

User Manual

MX2E for

Lotus Elise and Exige 2004-2020

Release 1.05





INDEX

1 – MX2E in a few words	3
2 – MX2E kit and installation	4
2.1 – Installation	5
3 – MX2E Main features	8
3.1 – Lap Times	10
3.2 – Icons	10
3.3 – LEDs	11
3.4 – The keyboard	11
4 – Menu	12
4.1 – Preferences	13
4.1.1 – Display	14
4.1.2 – Vehicle	16
4.1.3 – Shiftlights	21
4.1.4 – Meas Unit	22
4.1.5 – Date/Time	22
4.1.6 – Backlight	22
4.2 – Track Manager (and GPS Info)	23
4.2.1 – GPS Info	24
4.3 – Reverse Camera	24
4.4 – Trip	25
4.5 – Wi-Fi	26
4.6 – System Info	26
5 – On track application	27
5.1 – Connection to the PC	28
5.2 – Configuration	29
5.2.1 – CAN Expansions configuration	30
5.2.2 – Shift Lighths configuration	34
5.2.3 – SmartyCam configuration	35
5.3 – Managing a track on MX2E with Race Studio 3	38
5.4 – The device window	41
5.4.1 – Live measures page	42
5.4.2 – Online value forcing	42
6 – Data recall	44
7 – Data download and analysis	45
8 – Wi-Fi configuration	46
8.1 – Configuring MX2E dash-logger as an access point (AP)	48
8.2 – Adding MX2E loggers to an existing network	51
8.3 – Wi-Fi network settings	53
8.4 – The Internet connectivity	54
8.5 – Connection issues	54
8.6 – Working on Mac™ with virtualized Windows™	55
8.7 – Connected device visualization issues	57
9 – New firmware upgrade	58
10 – Rear cameras connection and management	59
Appendix 1 – ECU channels logged by MX2E	60
Appendix 2 – MX2E Adapter harness	63

1 – MX2E in a few words

MX2E is an AiM dash-logger designed to be installed on the following model years (Toyota engines only)

- Lotus Elise 2004-2020
- Lotus Exige 2004-2020

Please note: Lotus Elise-Exige model years 2004-2007 (**version with airbag only**) need an adapter harness (part number **V02593010**) shown in Appendix 2 while **Lotus Elise-Exige 2004-2007 without airbag are not supported.**



It is a full Plug and Play dash, completely compatible with the original connector.
It comes with an ad-hoc engineered cluster with 4 integrated buttons.

The dash/logger features:

- CAN connection for getting all the data coming from the stock ECU
- 6 alarm LEDs
- 10 RGB LEDs to help shifting the gear
- 2 turn lights indicator
- 14 digital switch inputs
- Rear camera input
- Seatbelt buzzer alarm
- Wi-Fi connectivity

It has an internal memory to record sampled data and comes with AiM GPS Module for Lotus that automatically gets lap times and a lot of important information very useful if using the vehicle on the track.

2 – MX2E kit and installation

MX2E kit (part number: **XA6MXPLEE0**) includes:

- MX2E dash-logger (1)
- washers and screws to fix MX2E (2)
- Cluster (3) with integrated GPS Module (5)

- Adapter harness (Lotus Elise-Exige 2004-2007 version with airbag only) (4) – part number **V02593010** (see Appendix 2).

Please remember: Lotus Elise-Exige 2004-2007 without airbag are not supported.



As shown in the image below GPS08 Module is to be placed in the dedicated housing of the cluster and its 5 pins Binder 712 male connector is to be connected to the corresponding female connector placed bottom left of MX2E back and labelled "EXP".



2.1 – Installation

To install MX2E follow these instructions.

Remove the original parts indicated in the image on the right.

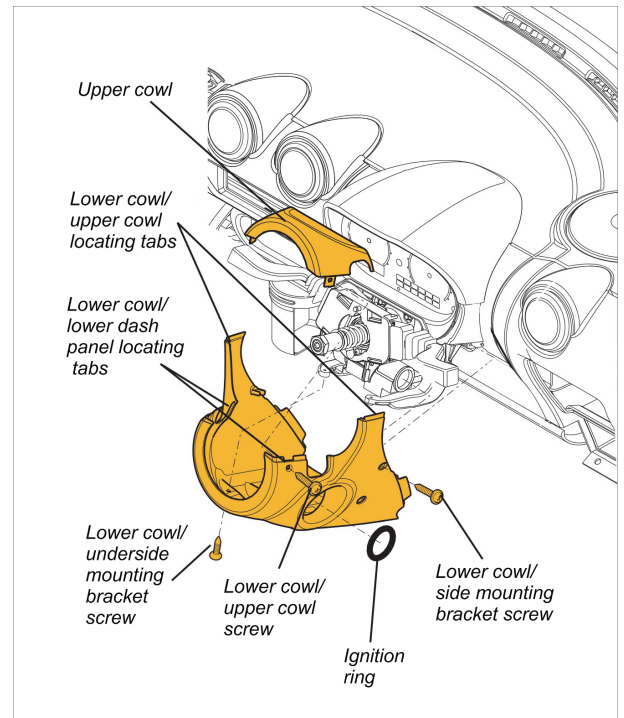

Remove the original cluster.

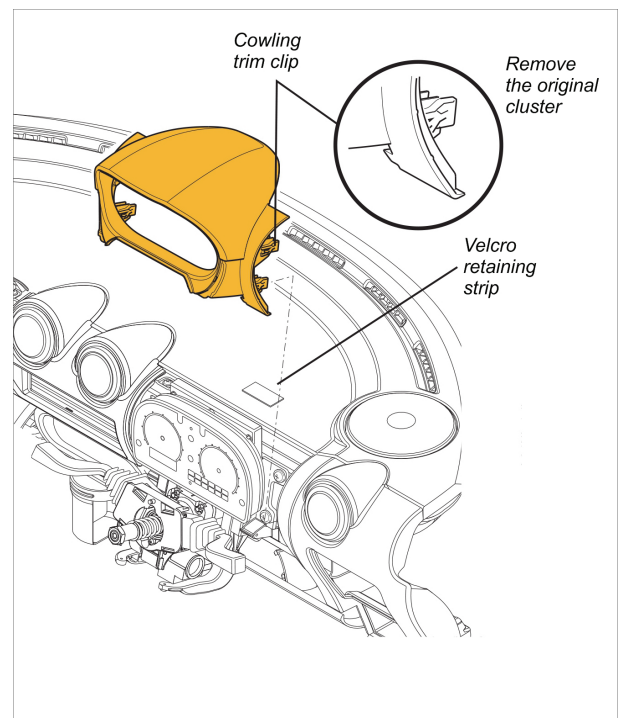

Remove the original dashboard.

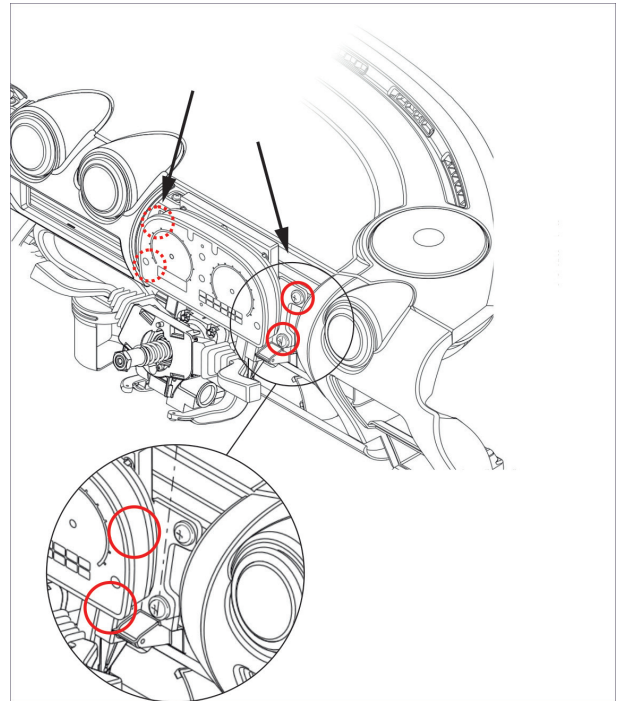

Install the MX2E on the original bracket.

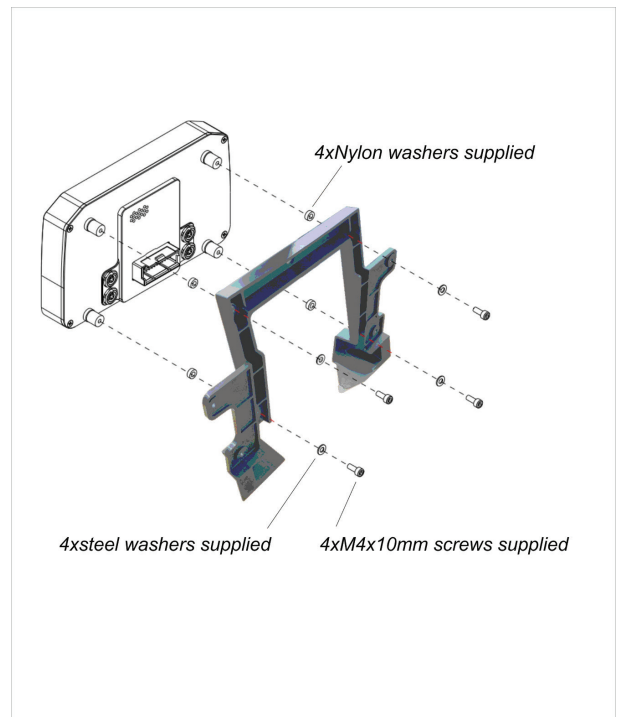



Connect MX2E to AiM cluster.

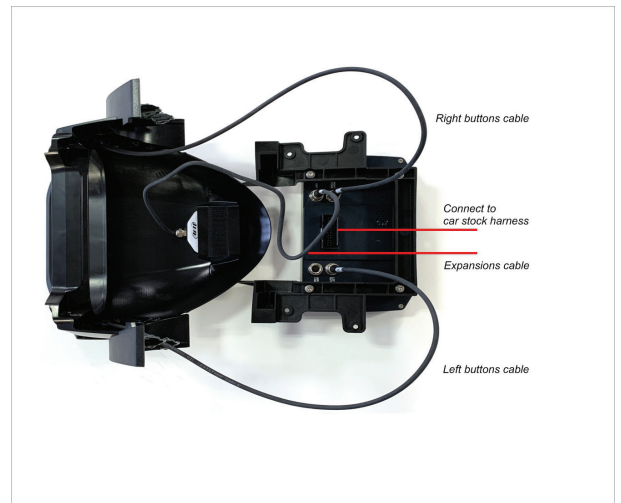

Install MX2E and AiM cluster.

Please note: in case the vehicle is a Lotus Elise Exige 2004-2007 with airbag MX2E needs an adapter harness (part number **V02593010**) to be placed between MX2E rear connector and the vehicle stock harness.

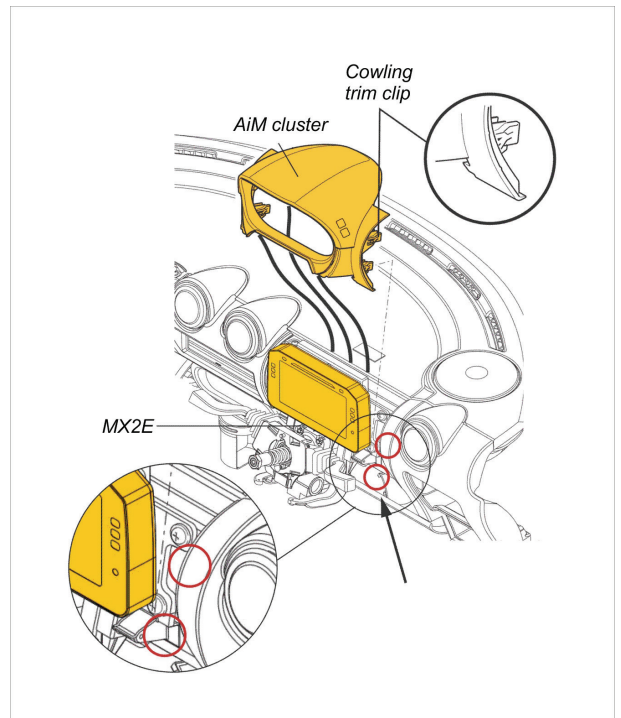

Re-install the original parts.

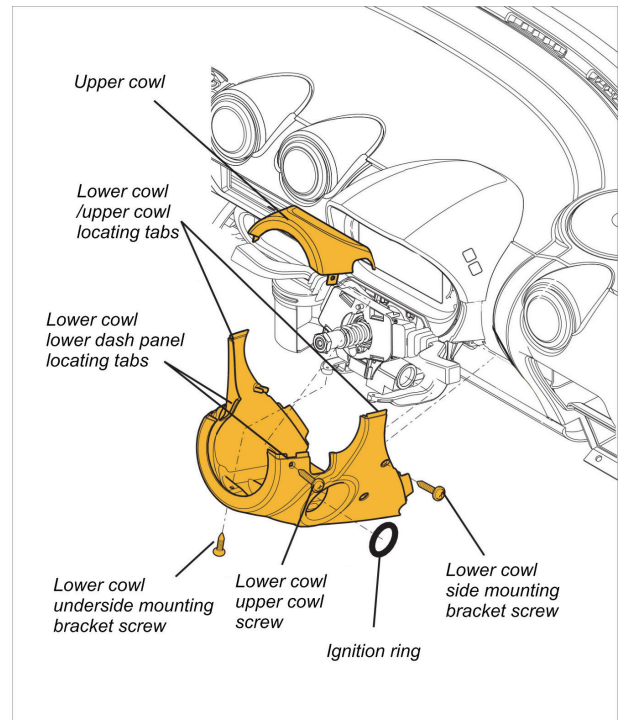

3 – MX2E Main features

MX2E has two different working modes: Road and Track, both always enabled.





The two layouts for **track** (top images) and **road** (bottom images) **usage** are shown below.

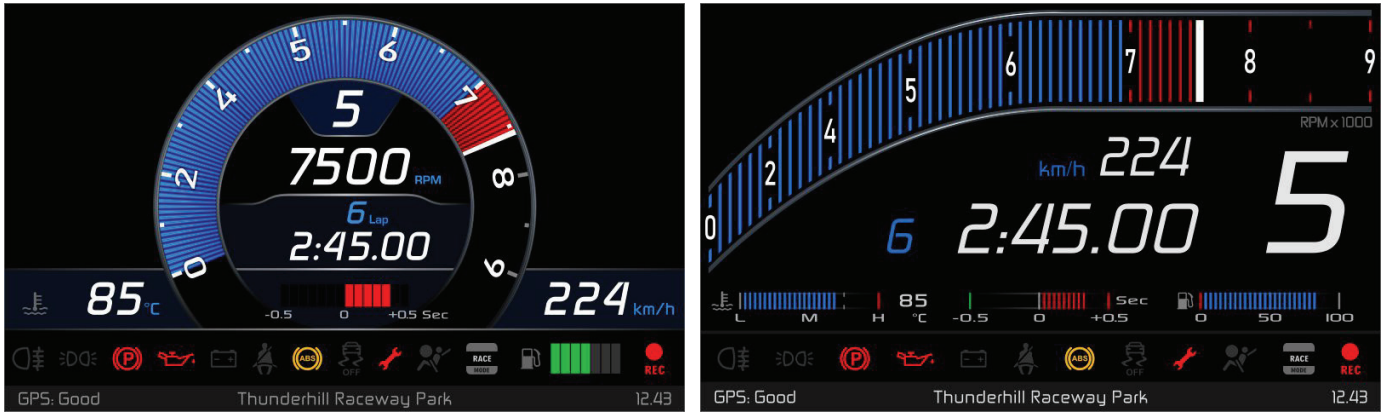

Bottom of the page an info line shows (from the left) GPS Status, track name and current time

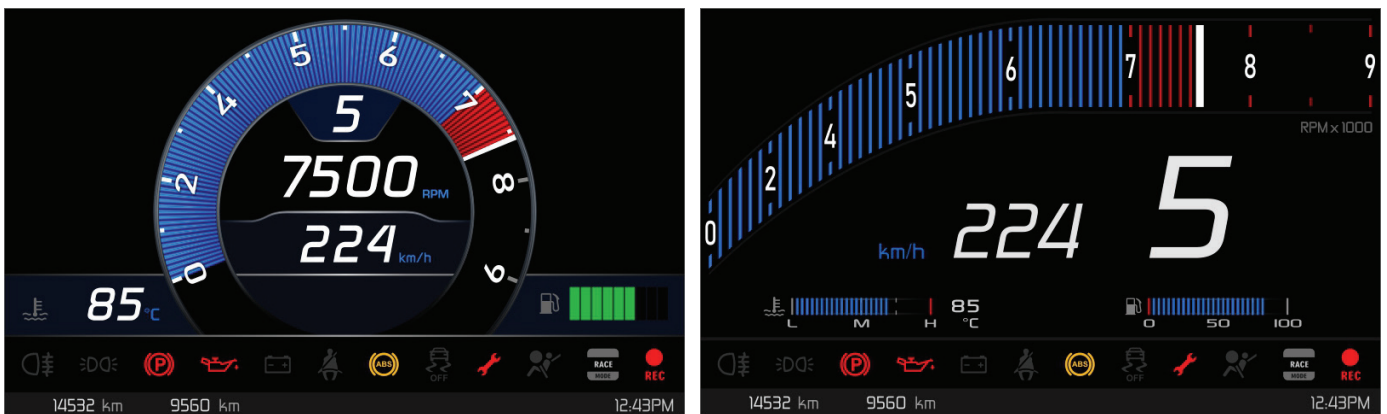

Bottom of the page an info line shows (from the left) two partial odometers and current time

In paragraph 4.1.1 "Display" data shown in the different layouts are specified.

3.1 – Lap Times

MX2E calculates and shows lap times using the GPS Module included in the kit.













Switching the vehicle on near a track the Module automatically recognizes it, loads start/finish coordinates and calculates lap times when these coordinates are crossed. If your track is not in the database you may always create and load it in the database using Race Studio 3 software, freely downloadable from AiM website at:

<https://www.aim-sportline.com/en/sw-fw-download.htm>



3.2 – Icons

Thanks to the wide number of icons available on its display, the dash-logger shows a good amount of information. Here follows explanation of their meaning.

	Rear fog light on		<ul style="list-style-type: none"> • ABS on or • ABS malfunctioning
	Position lights on		ABS off
	Handbrake is active		Service needed
	<ul style="list-style-type: none"> • Engine off or • oil pressure low 		Airbag off
	<ul style="list-style-type: none"> • battery voltage less than 10V or • alternator malfunctioning 		MX2E in race mode
	• Seat belt not fastened		MX2E recording

3.3 – LEDs

With reference to the image here below MX2E features 18 solid LEDs that gives you these information.

- Left direction light (1)
- Shift lights (2) made up of 10 LEDs; when all LEDs are on it is suggested to shift gear
- Right direction light (3)
- Hand brake on (4)
- Fuel Level low (5)
- Immobiliser on (6)
- Position lights on(7)
- Engine problems (8)
- High Beam on (9)

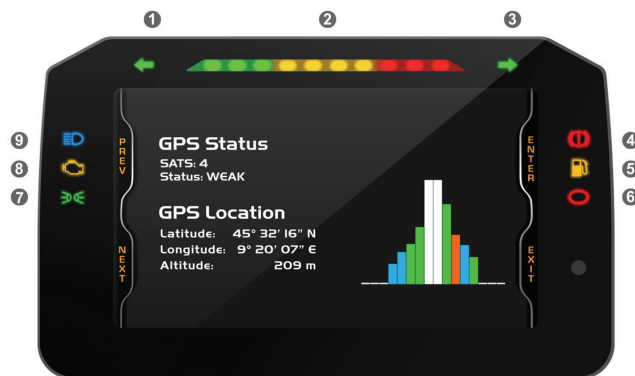

3.4 – The keyboard

MX2E comes with a dedicated plastic cluster with integrated GPS Module that features four lateral buttons, corresponding to the logger ones

- Top left: "Menu/<<"
- Bottom left: ">>"
- Top right: "MEM/OK"
- Bottom right: "VIEW/QUIT"



4 – Menu

Push **MENU** to enter MX2E “Preferences” and set some parameters. **Please note:** this is possible only if the vehicle is still.

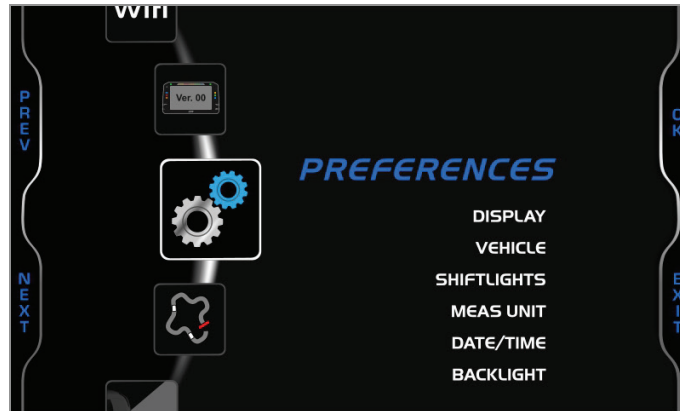

Use “PREV” and “NEXT” buttons to scroll the icons, “OK” to select the desired one and “OK” again to scroll the options. The icons stays for.



PREFERENCES

TRACK MANAGER

REVERSE CAMERA



TRIP

Wi-Fi

System Info



4.1 – Preferences

Press “MENU” button and then twice “OK” button to activate “Preferences” option. Use “NEXT” and “PREV” buttons to scroll the options. When an option is selected it changes colour according to the colour set in display page (in the image below the display is set blue)

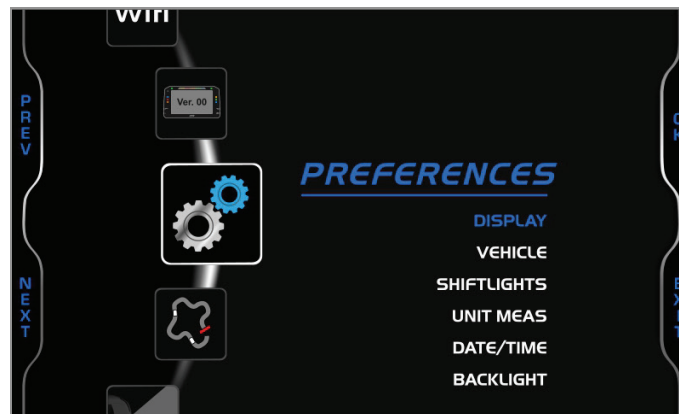

Available options are:

- Display
- Vehicle
- Shiftlights
- Unit Meas
- Date/Time
- Backlight

4.1.1 – Display

Once “Display” option is activated (blue in the previous image) press “OK” to enter the related page.

Available options are:

- Layout: Road (left image below) or track (right image below)
- Theme: analog or digital
- Color: blue, purple, yellow or white

Selecting Track layout (right image below) two more options can be available:

- Lap: rolling, static, predictive or pred+/- and
- Ref. Lap (with pred +/- only): test best or day best; “ref lap” is the lap that the system uses as reference to compute the gap between the current lap and the reference one.

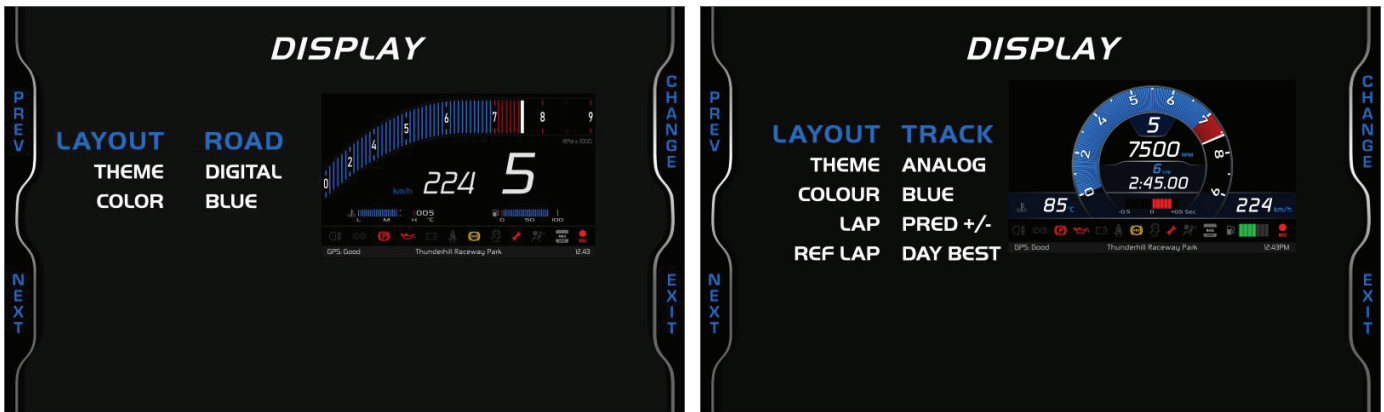



As shown here below Track (left) and Road (right) layout shows different information.

Number	Function	Track	Road
1	Engaged gear	✓	✓
2	RPM	✓	✓
3	Lap Number	✓	
4	Lap time	✓	
5	Pred +/-	✓	
6	Water Temperature	✓	✓
7	Speed	✓	✓
8	Fuel level	✓	✓

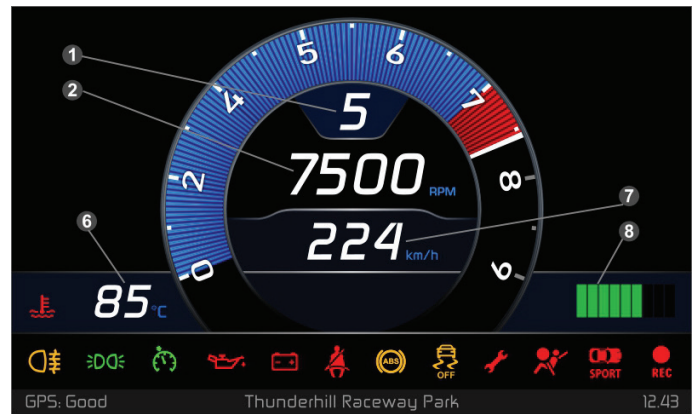
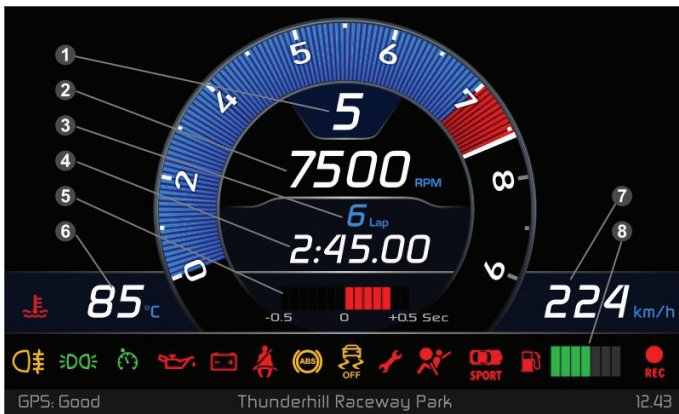

Water Temperature (6) and Fuel (8) icons works as follows:

Water temperature icon:

- for temperature value less than 40°C the icon is shown blue
- for temperature value over 100° the icon is shown red

Fuel icon: if left fuel is less than 25% of fuel tank capacity the icon is shown yellow.

4.1.2 – Vehicle

From “Preferences” page Scroll to “Vehicle” option using “NEXT” button and press “OK”. Here it is possible to select:

- model
- speed and
- gears
- modules
- buzzer.

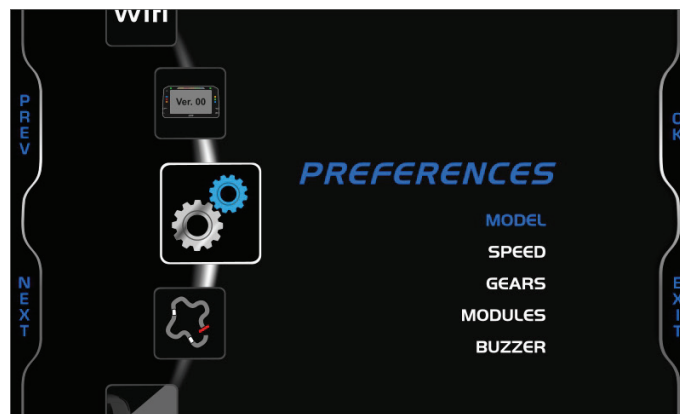

Use “OK” button to enter “MODEL” page and:

- “SELECT” button to activate model selection (left image below)
- “PREV” and “NEXT” buttons to select the model year (right image below)
- “OK” button to confirm; MX2E will automatically reboot

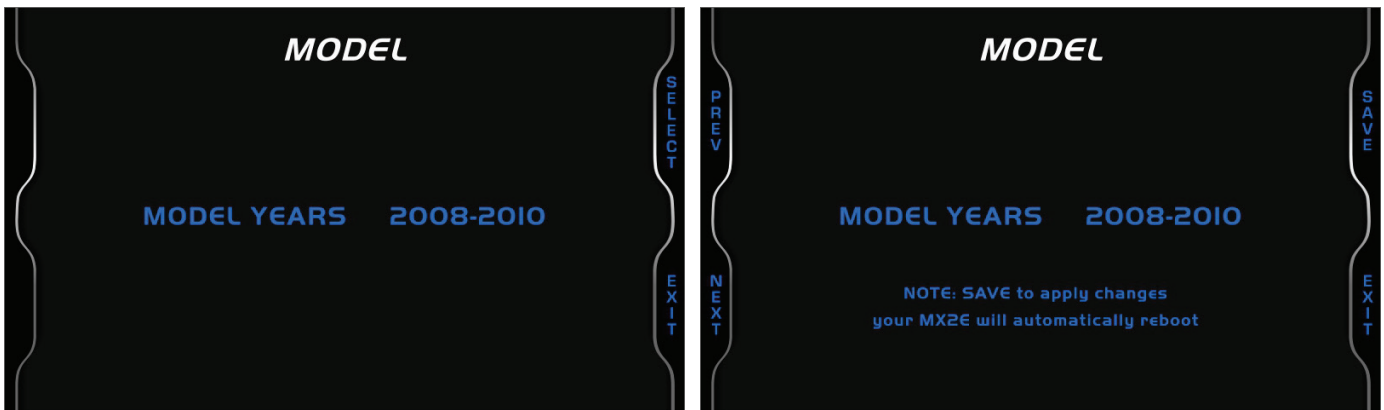

Available model years are:

- 2004-2007 (adapter harness part number **V04000000** needed)
- 2008-2010
- 2011-2020



From "Preferences" menu use "NEXT" button to scroll to "SPEED" option and:

- "ENTER" button to enter speed page (left image below)
- "PREV" and "NEXT" button to select the desired option
- "CHANGE" button to set the desired reference speed between ECU or GPS speed (right image below)
- "OK" button to confirm; MX2E will automatically reboot

(Reference) **Speed** is used to compute lap times and can be :ECU or GPS.

A **correction** factor to the shown speed is available. This last is useful to correct possible modifications of the vehicle like the use of wheels with different circumference on the two axles. Range values are from -15% to + 15%.

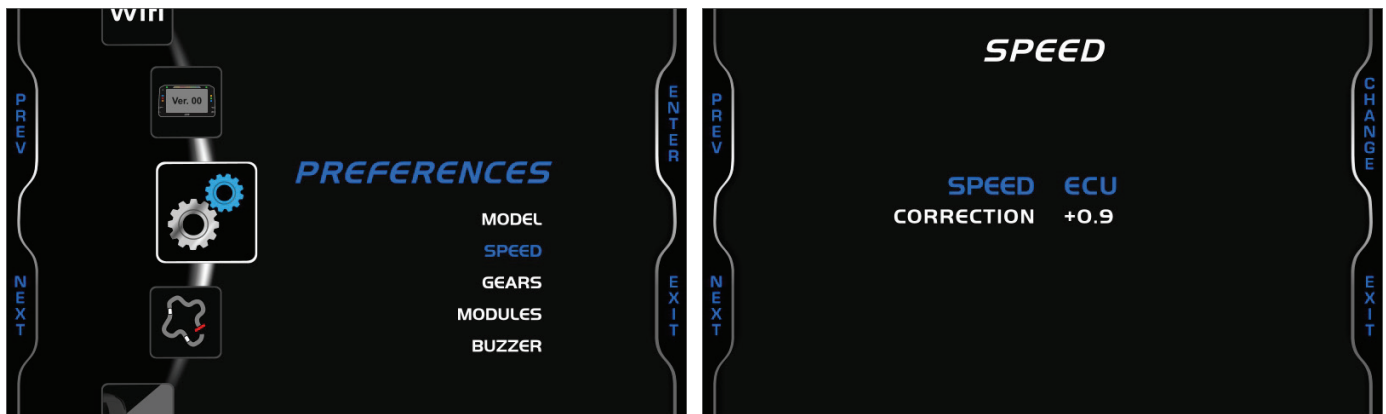

From "Preferences" menu use "NEXT" button to scroll to "GEARS" option and press "ENTER".

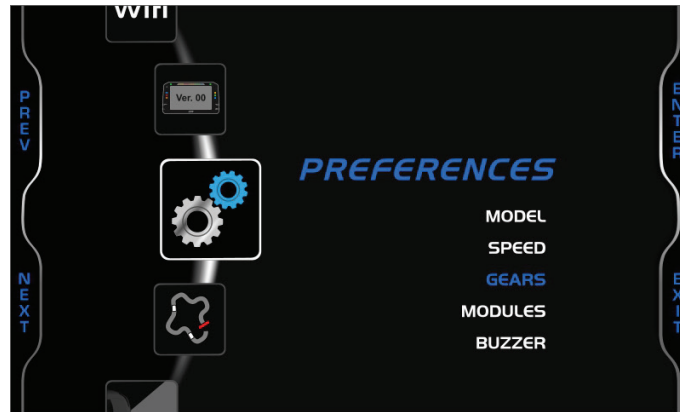

Available options are:

- Sequential (left image below)
- Manual (right image below) and
- Not set: does not show engaged gear on MX2E display; it allows gear calculation but does not show the value on the display

Selecting "Manual" option four more options can be available:

- Calc. gears: yes/no
- Reset gears: yes/no
- Start calc (with calc gears "yes" only)
- Reset (with calc gears and reset gears "Yes" only)

To perform "Start calc" and "Reset" scroll to the related option and press "OK" button.

The calculation procedure starts as soon as speed is different from zero. Please keep each gear for 2-5 seconds and proceed up to the highest gear. In this phase gears are not correctly displayed. Once the last gear is reached the indication becomes correct; check if lower speeds have been correctly computed and displayed on the screen, downshifting through all the gears. If not repeat the calculation.

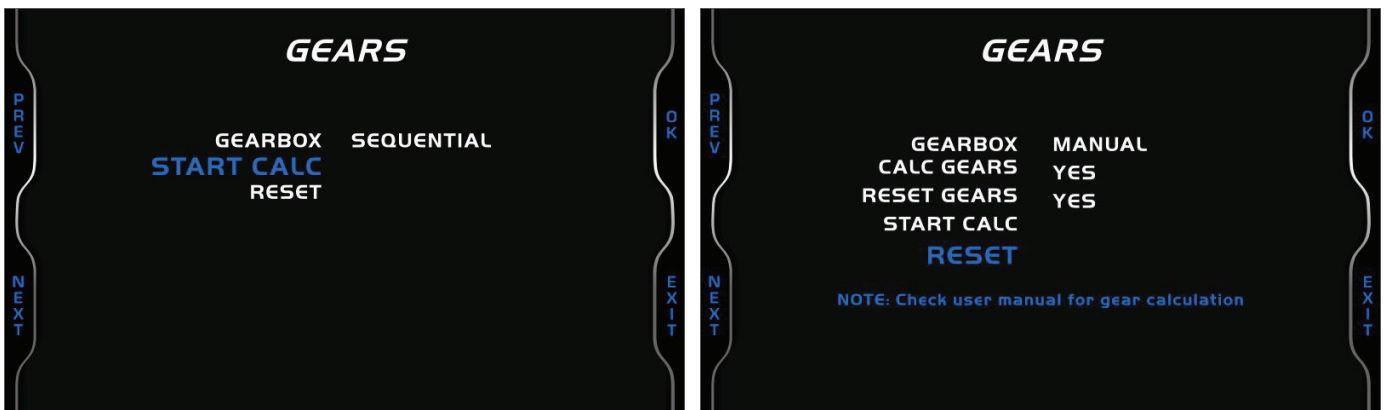

From "Preferences" menu use "NEXT" button to scroll to "MODULES" option and press "ENTER".

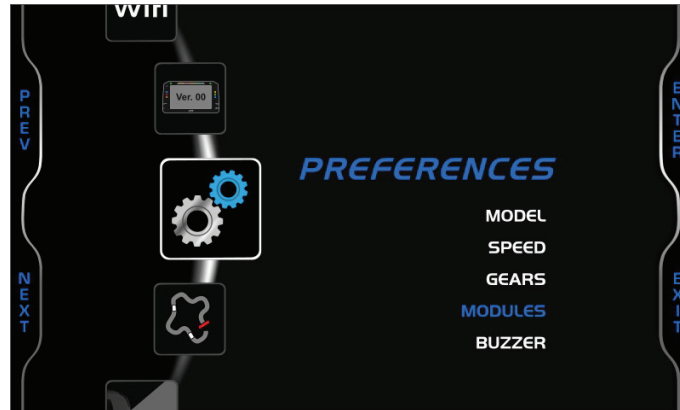

Allowed modules are AIRBAG and OBDII REQ.

- **AIRBAG** can be installed/not installed; in some cases it is removed, for example to race
- **OBDII REQ:** enabled/disabled; OBDD request are typically diagnostics requests that add channels to the ECU protocol; they can be disabled to connect a diagnostic instrument or another device that uses the OBDII protocol

Use "CHANGE" button to switch the options and "EXIT" to quit and save.

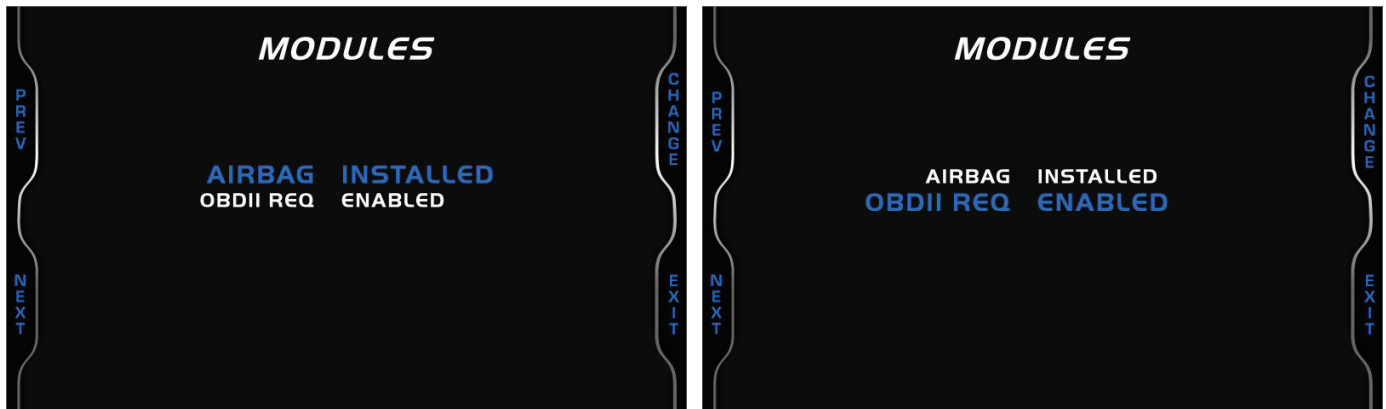

From "Preferences" menu use "NEXT" button to scroll to "BUZZER" and press "ENTER".

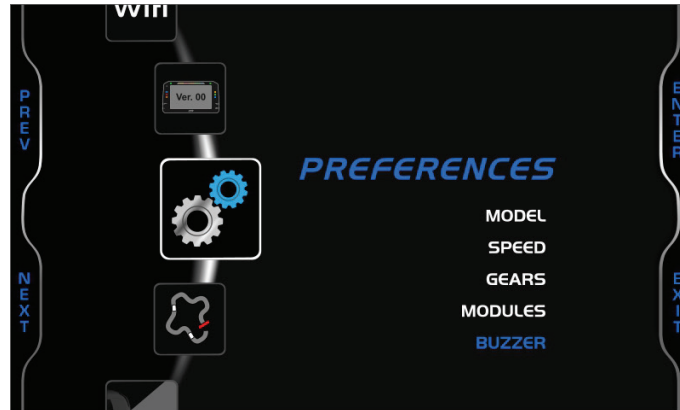

Available buzzers are SEATB BUZ and LIGHT BUZ.

- **SEATBELT BUZ** can be enabled/disabled; it allows to disable the seatbelt buzzer
- **LIGHT BUZ**: enabled/disabled; it is possible to enable a buzzer that in given conditions avoid sidelights to remain on running the vehicle battery out. Given conditions are:
 - MX2E on
 - vehicle engine off (RPM = 0)
 - sidelights on
 - a vehicle door open

Use "CHANGE" to switch the options and "EXIT" to quit and save.

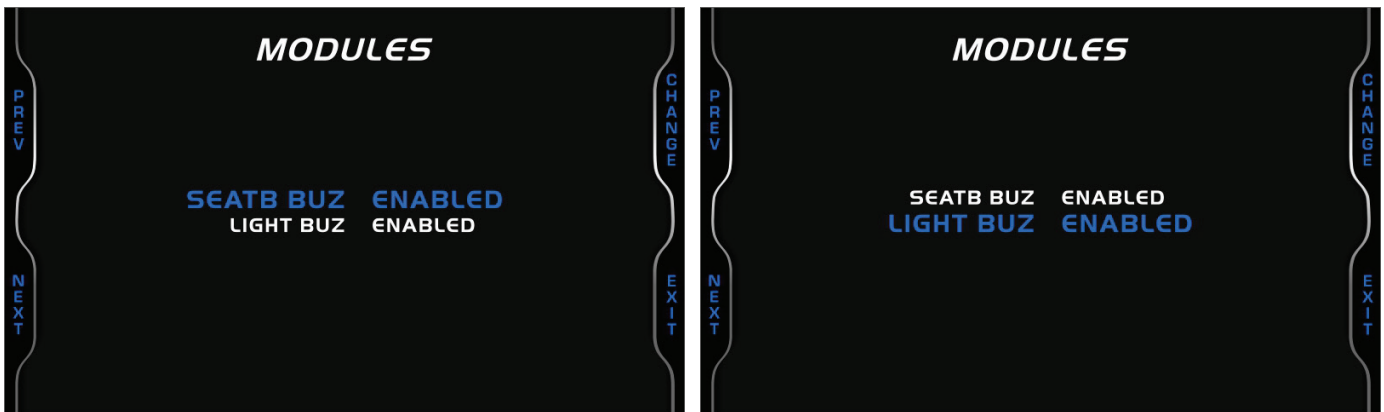



4.1.3 – Shiftlights

From “Preferences” page Scroll to “Shiftlights” option using “NEXT” button and press “OK”.

In this page it is only possible to see the shift lights configuration set through Race Studio 3 software as well as enable/disable them pressing “CHANGE”. Use “PREV” and “NEXT” button to scroll the options.

Here below: on the left shift lights are linked to the engaged gear while on the right they are not. Please refer to paragraph 5.2.2 to know how to configure MX2E shift lights.

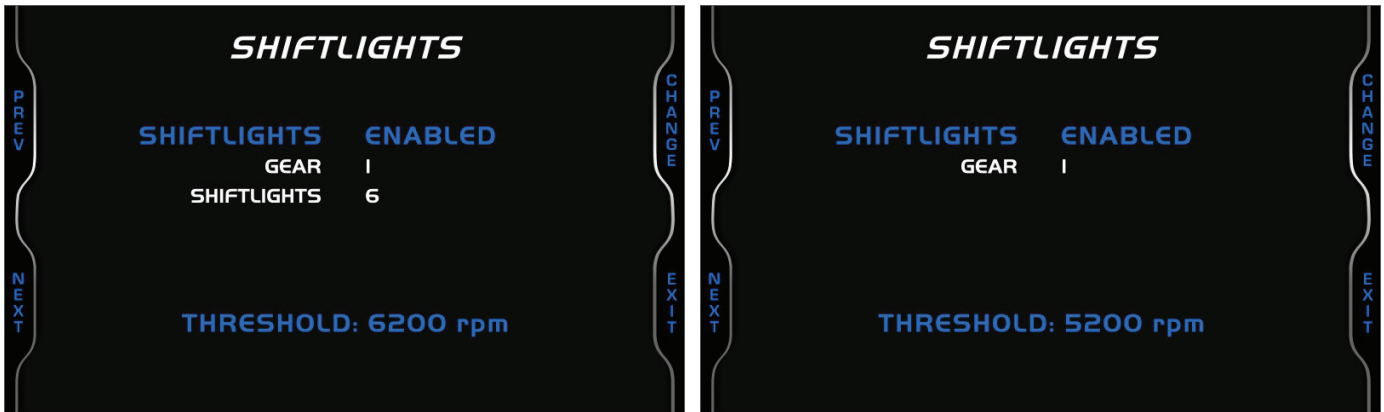

4.1.4 – Meas Unit

From “Preferences” page Scroll to “Meas Unit” option using “NEXT” button and press “OK”.

Here it is possible to set:

- Speed: km/h or mph
- Temperature: Fahrenheit or Celsius

4.1.5 – Date/Time

From “Preferences” page Scroll to “Date/Time” option using “NEXT” button and press “OK”.

Here it is possible to set date and time format. The setting is shown on the page bottom line (09:26:05 AM 11/20/2019).

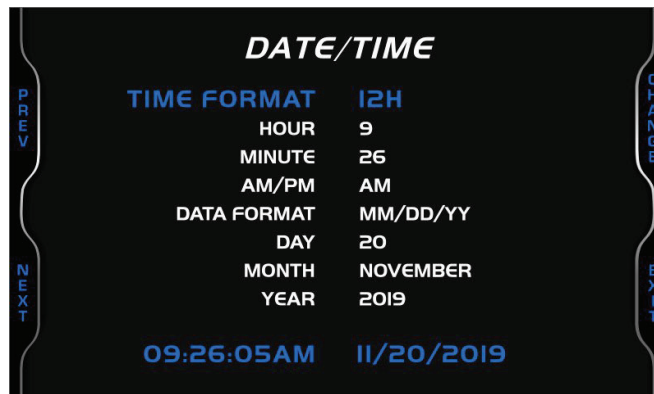

4.1.6 – Backlight

From “Preferences” page Scroll to “Backlight” option using “NEXT” button and press “OK”. Available options are “Manual” and “Auto”

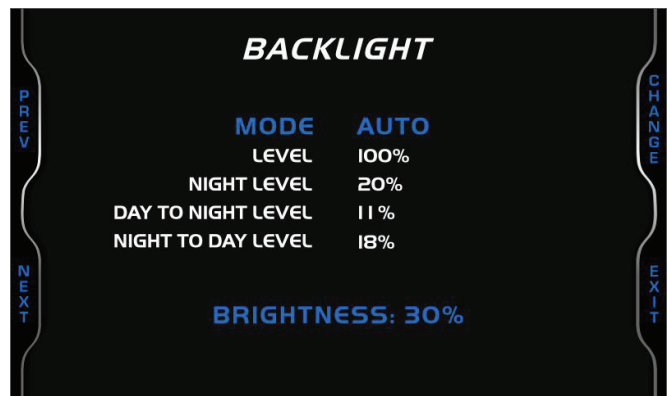
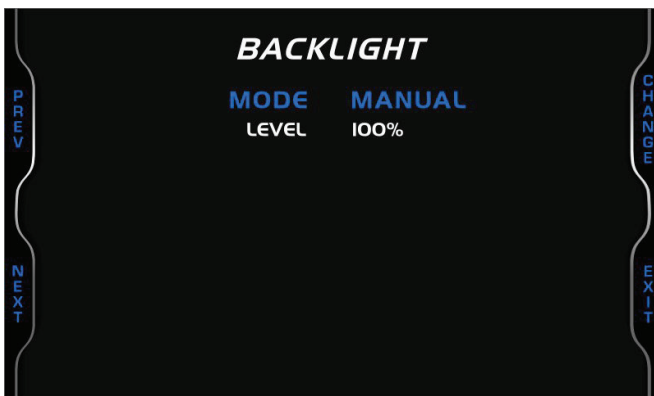

In **Manual** Mode one level of brightness is set and maintained independently from the external light conditions.

In **Auto** Mode you may:

- set the **Day Level**; at the desired threshold the dash logger commutes the display brightness
- set the **Night Level**: when the Light Sensor reads a brightness level higher than the threshold, the display is enlightened at the level defined by this parameter.
- set the **Day to night level**: at the desired threshold the dash logger commutes the display brightness;
- set the **Night to day level**: at the desired threshold the dash logger commutes the display brightness

“Night to day level” is to be always higher than “Day to Night threshold”.



4.2 – Track Manager (and GPS Info)

From “MENU” page scroll to “Track Manager” option using “NEXT” button and press “OK”.

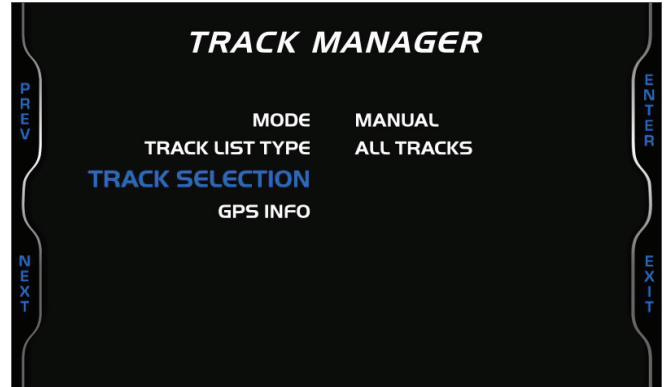
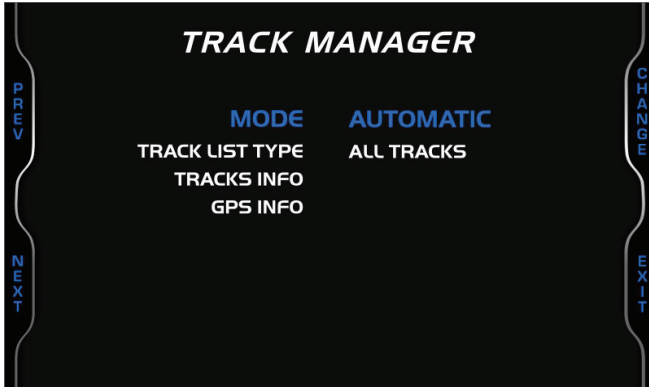

In this page it is possible to set the track management of MX2E. Available options are “Auto” and “Manual”.

Automatic:

MX2E automatically recognizes the track it is running on, loads the start/finish line and the possible splits coordinates and calculates lap and split times. This is the best mode in most cases. Use:

- “PREV” and “NEXT” buttons to scroll the options
- “CHANGE” button to change the setting
- “EXIT” to save and exit

Manual:

In this mode the track can be selected from the internal database. This mode is to prefer when multiple track configurations are available nearby. In this case MX2E would anyway recognize the track but would need at least one complete track lap.

The list of available tracks can be set:

- nearest: shows only tracks in a 10 km distance
- all: shows all tracks stored in the system in alphabetical order
- custom: shows only the tracks you have previously created (learning mode)

To select a specific track:

- scroll to “Track selection option” and press “ENTER”
- you enter “Track Selection” page (right image below)
- scroll all tracks and select the desired one
- press “ENTER” button and the selected track appears bottom on the page (Dominon VA – in the example below)
- press “EXIT” to save and exit.



4.2.1 – GPS Info

In Track Manager page scroll to “GPS Info” option and press “**ENTER**”. The page shows GPS Status with number of connected satellites and status signal as well as GPS Location with the coordinates of the place it currently is.

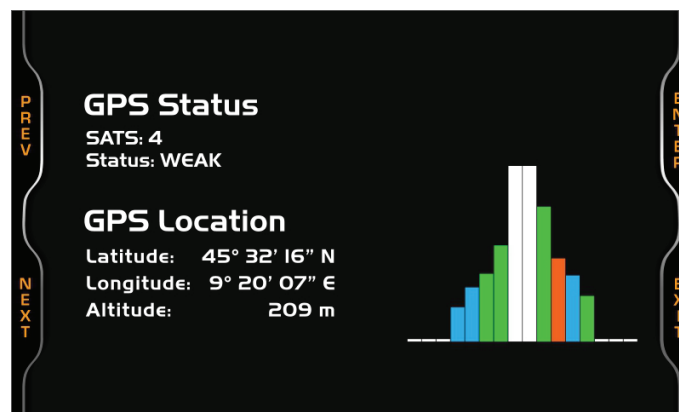

4.3 – Reverse Camera



From “MENU” page scroll to “Reverse Camera” option using “**NEXT**” button and press “**OK**”.

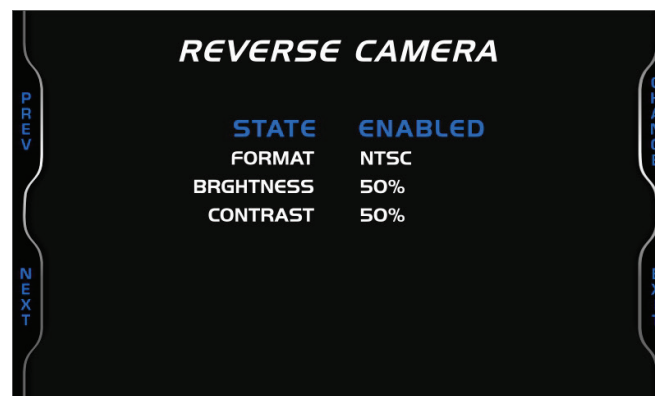

Available options are:

- State: enabled or disabled
- Format: NTSC or PAL
- Brightness and contrast: from 10% to 50%

When reverse camera is **enabled** it works differently according to the gears setting (see paragraph 4.1.3 for further information); to say:

- if gear is set “Sequential” the reverse camera activates automatically as the reverse gear is engaged
- if gear is set “Manual” you need to shortly press “illumination control” button on the car steering column



4.4 – Trip

From “MENU” page scroll to “Trip” option using “NEXT” button and press “OK”.

MX2E features 4 user odometers, labelled Usr 1 – Usr 4, plus a System Odometer. This last one can only be reset by an AiM or a Lotus dealer.

Each odometer can be activated/deactivated and/or reset. To manage an odometer:

- select it and press “CHANGE”
- the system enters “Counters” page (right image below); in this page each odometer shows also the total working time

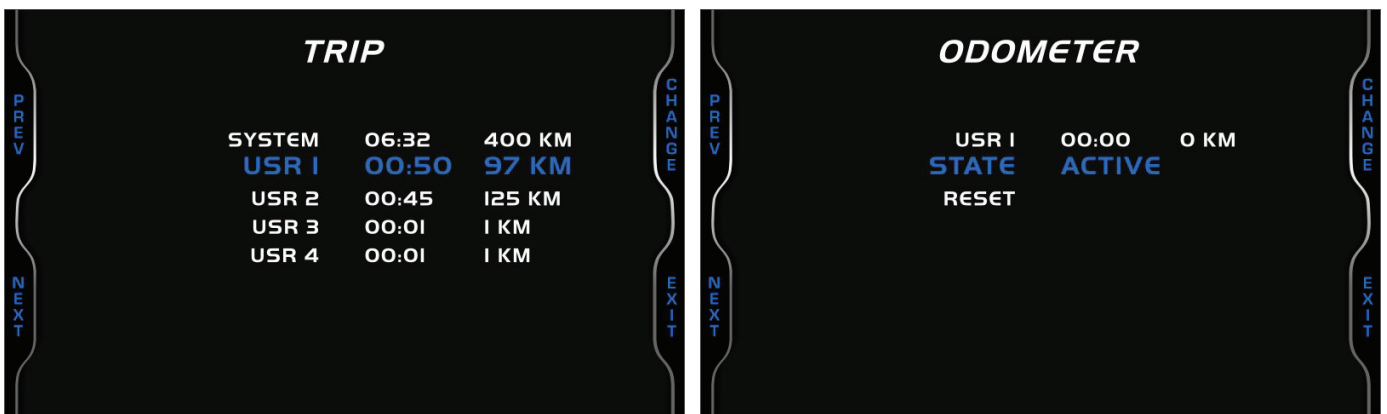

The buttons are for:

- “CHANGE”: change the status or clear the odometer
- “PREV”/“NEXT”: scroll the options
- “EXIT”: save and exit



4.5 – Wi-Fi

From "MENU" page scroll to "Wi-Fi" option using "NEXT" button and press "OK".

MX2E features a Wi-Fi module used to communicate with the PC to download sampled data after the test and to transmit/receive tracks to/from GPS Module.



Wi-Fi available "Modes" are:

- Auto: Wi-Fi is ON when the vehicle is stopped and OFF when RPM value is >850 or speed value is >10 km/h
- ON: Wi-Fi is always on
- OFF: Wi-Fi is always OFF

Select Channel function is for expert users only; here it is possible to select which Wi-Fi channel to use; available option are:

- AUTO (default – recommended)
- 1
- 6
- 11

"Wi-Fi Reset CFG" resets the Wi-Fi configuration and is very useful if the password is forgotten: press "OK" to reset the password.



4.6 – System Info

From "MENU" page scroll to "System Info" option using "NEXT" button and press "OK".

This page shows serial number as well as firmware and booter version of your MX2E.

Press "ENTER" button to enter "Net Info" page that shows serial number and firmware version of the connected GPS Module.



5 – On track application

If using the vehicle on a track, for track days or competition and wish to take the maximum advantage from MX2E, an optional AiM Data Hub is needed (left image below) so to install a few sensors (suspension potentiometers, brake pressure..) and connect them to AiM Channel Expansion (right image below).



The steps to follow are:

- install Data Hub and connect it to connector labelled “EXP” rear on MX2E
- plug Channel Expansion connector cable in one of DataHub connectors
- plug the sensors in Channel Expansion connectors
- connect MX2E to the PC via Wi-Fi
- configure MX2E according to the sensors you have installed
- calibrate the sensors
- run your test
- download the data, in order to analyse them

A quick review of sampled data is always available on the display, without downloading them (see paragraph 6 Data Recall)

Using the 5 pins Binder 712 female connector labelled “EXP” rear of MX2E it is possible to connect the dash/logger to AiM Channel Expansion and LCU-One CAN. The image below shows an example of connection scheme.

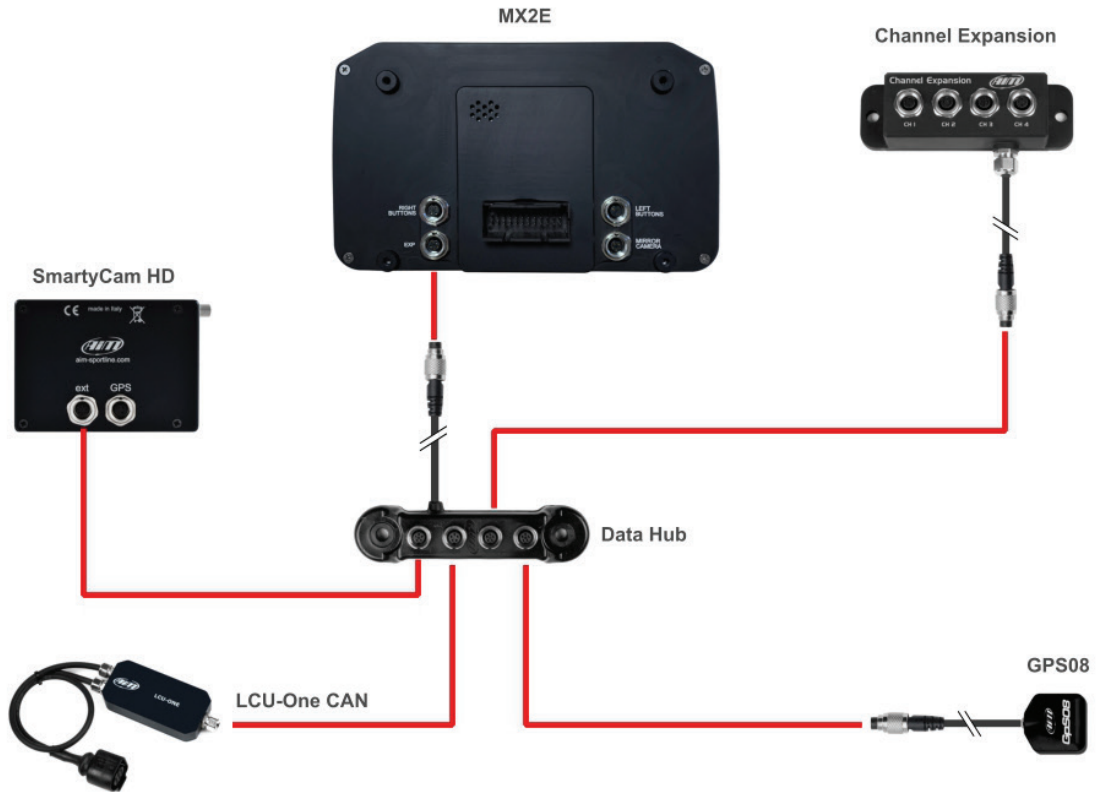

5.1 – Connection to the PC

AiM **Race Studio 3** software (from Race Studio 3.30.11) configures MX2E, manages its tracks database as well as checks other device functions through the software device window (see paragraph 5.4). Connect MX2E to the PC via Wi-Fi.

5.2 – Configuration

Once MX2E connected to the PC

- click configuration icon () and configurations page appears
- click “New” and new configuration panel appears: select an “MX2E” logger and press “OK”; when performing subsequent configurations “Select Configuration” panel shows on top the last four devices you configured.



5.2.1 – CAN Expansions configuration

To set a CAN Expansion:

- enter “CAN Expansion” layer
- press “New Expansion” button
- a panel showing all available expansions shows up: select the one to add (LCU-One CAN in the example) and press “OK”.

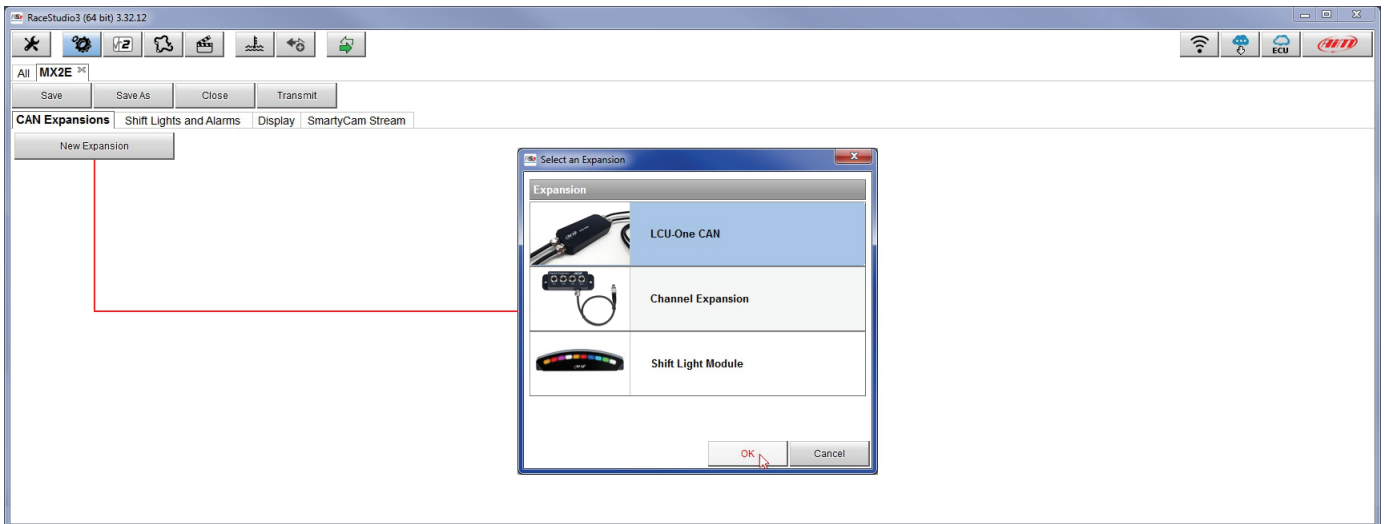

Setting LCU-One CAN

To set an LCU-One CAN:

- press “New Expansion” button;
- select “LCU-One CAN” and press OK
- name the LCU One and fill in its serial number or press “Get SN from a connected expansion” to receive the serial number from the connected LCU-One
- select the multiplier to calculate AFR from lambda (in the example “14.57 Gasoline”) or add a custom value pressing “Add Custom Value” (the related panel shows up)
- set the LCU One channels double clicking on each channel and setting the panel that shows up
- press “Close” to save and exit

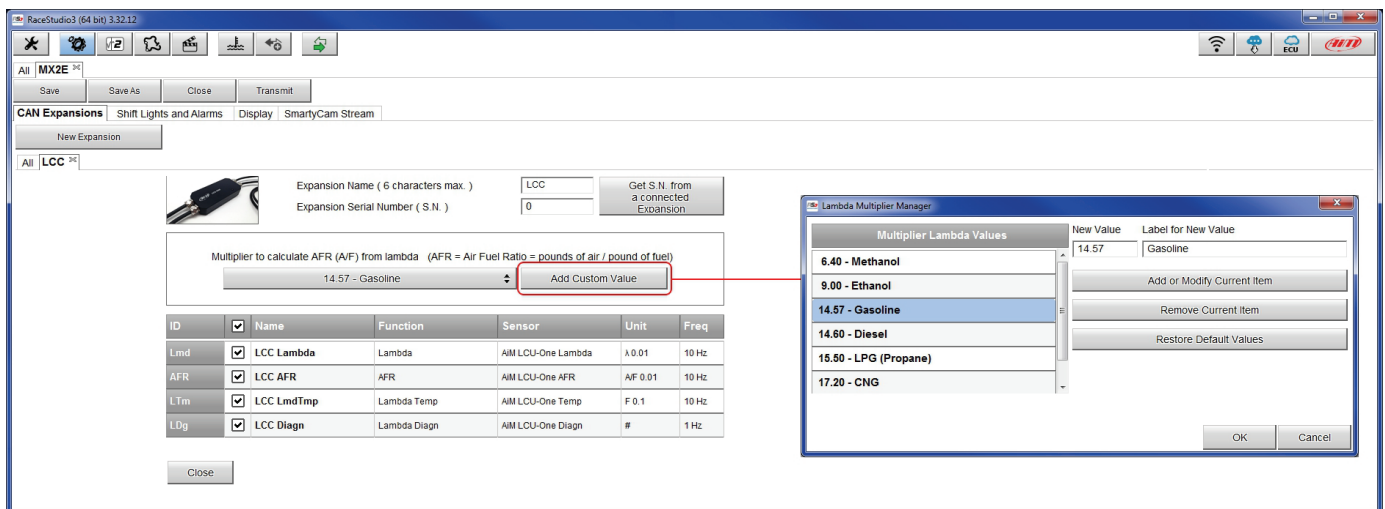

Setting Channel Expansion

To set a Channel Expansion:

- press “New Expansion” button; if you have already set an expansion the layer only shows the other supported expansions.
- select “Channel Expansion” and press OK
- name the Channel expansion and fill in its serial number or press “Get SN from a connected expansion” to receive the serial number from the connected Channel Expansion
- set each channel double clicking on each channel and setting the panel that shows up
- press “Close” to save and exit

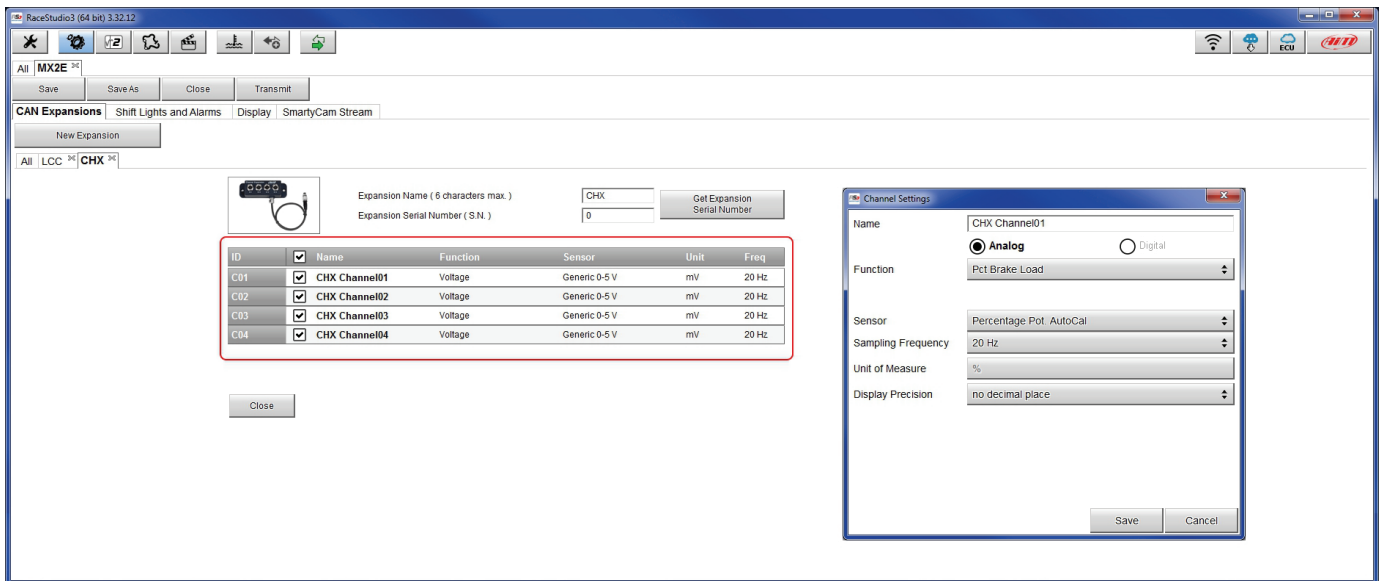

Setting Shift Light Module

To set Shift Light Module :

- press “New Expansion”; in this example all supported expansions have already been loaded; this is why no choice panel is shown but Shift Light Module tab is automatically added to the configuration
- click the “Setting” icon on the right of the configuration panel
- available options are: “a LED stays on if its threshold is exceeded” or “a LED stays on until another LED with higher threshold is turned on” (1)
- if engaged gear is shown shift lights can be set depending on that value enabling the related checkbox (2); in this case fill in max gear number of the vehicle and set RPM threshold value for each gear
- to decide how LED switching on works press Histogram button right of each LED row and “Shift Lights settings” panel shows up (3)
- available options are: switch a LED on and switch it off when the following LED switches on (use differential automatic value calculation) or switch a LED on and keep it on when the following one switches on (use linear automatic value calculation) (4).
- press “OK” on both panel
- press “Transmit” to transmit the configuration to MX2E.

Shift Light Module can be set as “Shift Lights and Alarm” tab (paragraph 5.2.2) or in a different way. There is no automatism in the software.

The screenshot shows the RaceStudio3 interface with the following components:

- Main Window:** Displays a gear selection table with 10 LEDs. The table has columns for Gear (1-10) and Shift Light (1-10). The 10th LED has a gear selection icon (histogram) next to it.
- Shift Lights Options Dialog:**
 - Step 1: "Choose a sequence mode of shift lights" with radio buttons for "A LED stays on if its threshold is exceeded" (selected) and "A LED stays on until another LED with higher threshold is turned on".
 - Step 2: "Choose the engine rpm channel" set to "RPM".
 - Step 2: "Gear dependent shift lights" checkbox is checked, and "Max gear number" is set to 6.
 - Step 2: "Choose the gear channel" set to "Lgear".
 - Step 2: A table for "Select colors and threshold values for shift lights" with columns for Gear (1-10) and Shift Light (1-10). Each cell contains a color-coded LED icon and a threshold value (e.g., 5200, 5400, 5600, 5800, 6000, 6200, 6400, 6600, 6800, 7000).
- Shift Lights Settings Dialog:**
 - Step 4: "Choose how to manage automatic calculated value" with radio buttons for "Use differential automatic value calculation" (selected) and "Use linear automatic value calculation".
 - A graph shows "rpm" vs "LED" (1-10) with a curve connecting points at 4950, 5200, 5400, 5600, 5800, 6000, 6200, 6400, 6600, 6800, and 7000.

Please note: for any further information about AiM CAN Expansions refer to the related user manuals available at AiM website www.aim-sportline.com documentation area, products section.

Removing an AiM CAN Expansion

To remove an AiM CAN expansion:

- activate "All" tab in "CAN Expansion" layer
- right click on the expansion to remove
- select "Delete Selected Expansion" option and confirm

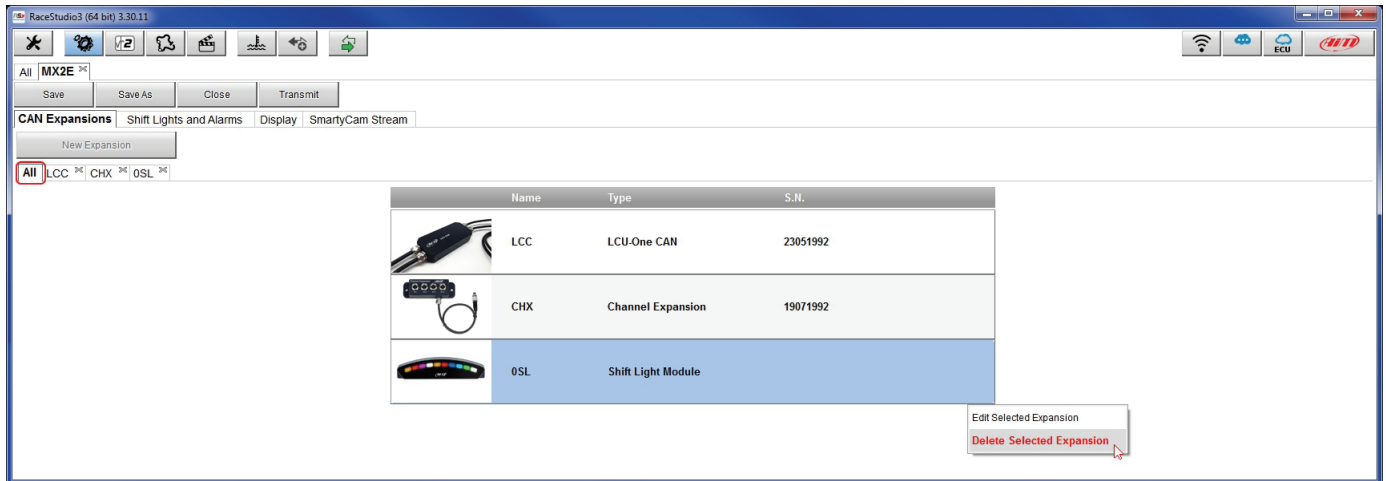

5.2.2 – Shift Lights configuration

To configure MX2E shift lights activate the related layer; this page shows up.



To use the LED bar as shift lights click this icon (⚙️) and the setting panel shows up. Configure:

- RPM value that switches the single LED on
- LED sequence enabling the desired option:
 - a LED stays on if its threshold is exceeded
 - a LED stays on until another LED with higher threshold turns on or
- connect the shift lights to the engaged gear enabling “Gear dependent shift lights” checkbox;

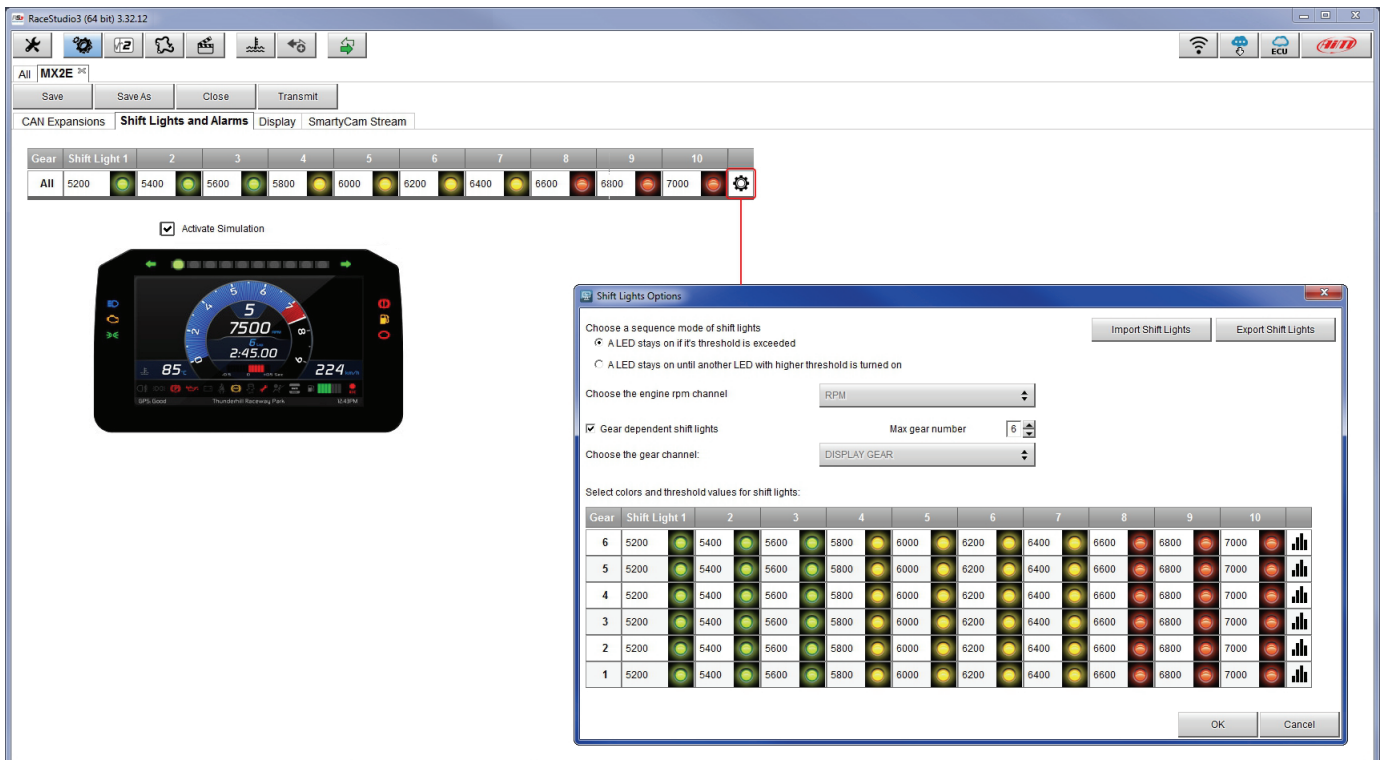

5.2.3 – Display configuration

To configure MX2E display activate the related layer; this page shows up.

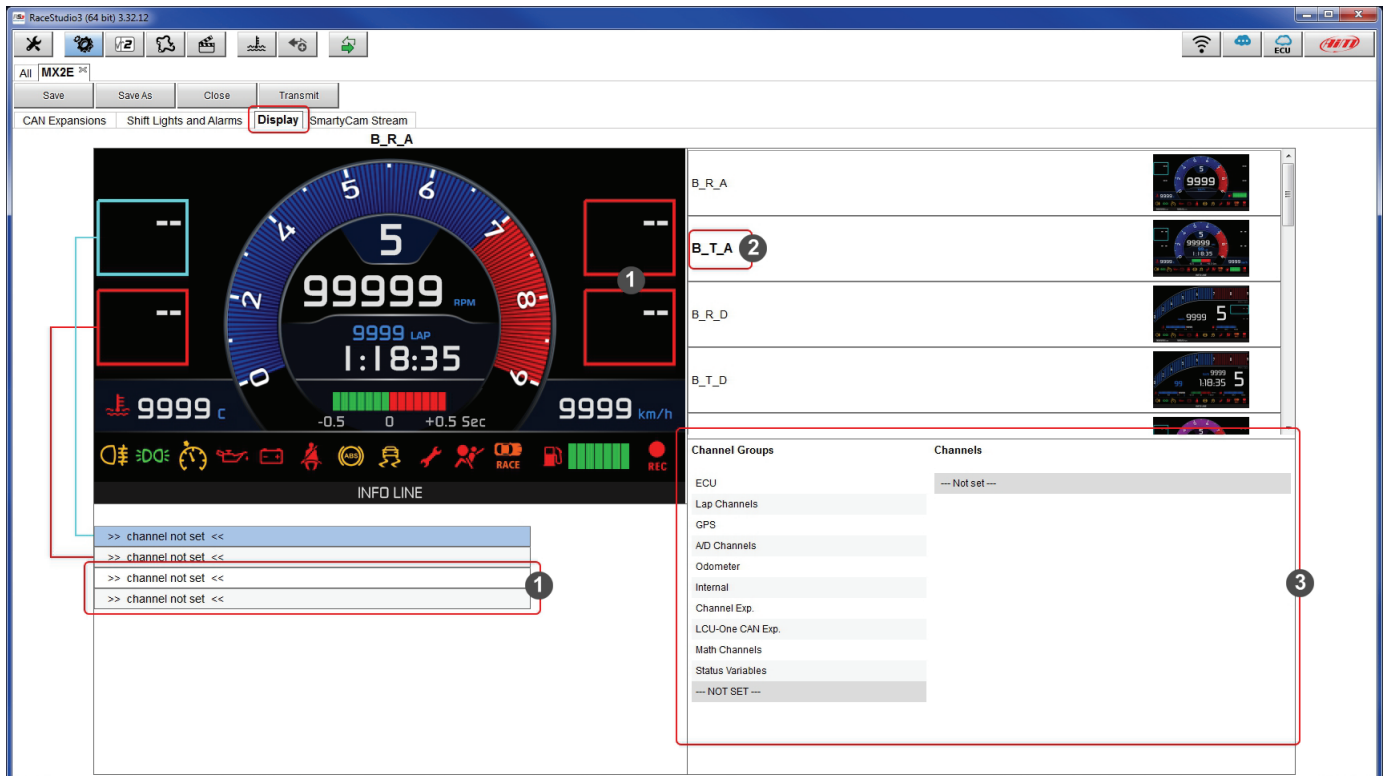

Top left panel shows MX2E display layout. It features four freely configurable lateral boxes whose setting row are behind the panel.

- in light blue is the box that is being configured and the corresponding setting row becomes light blue too
- each box is settable through the corresponding row.

Top right are all available MX2E display layout. They are labelled by an acronym (2), **B_T_A** in the example, whose meaning is as follows:

- The first letter stays for display colour; available options are:
 - **B for blue** as in the example
 - P for purple
 - W for white
 - Y for yellow
- the second letter stays for display layout; available options are:
 - R for Road
 - **T for track** as in the example
- the last letter stays for display theme; available options are:
 - **A for analog** as in the example
 - D for digital

Bottom right is the channels panel where all available channels are shown (3).

To set MX2E display:

- select the box to set in the top left panel: the corresponding row in the bottom panel becomes light blue (1)
- select the group of channels the channel to set belongs to (2)
- double click on the channel to set (3)
- press "Save" on the software top left keyboard (4)
- press "Transmit" to transmit the configuration to MX2E (5)

Please note: when transmitting the configuration to MX2E all display layouts are transmitted. This is why AiM strongly suggests to set them all so to always have **plenty of available configurations** you can easily identify from its colour and theme. This allows to switch from one layout to the other without being obliged to reconfigure your MX2E. **Moreover** all channels set in the different layouts are always sampled and recorded by MX2E.

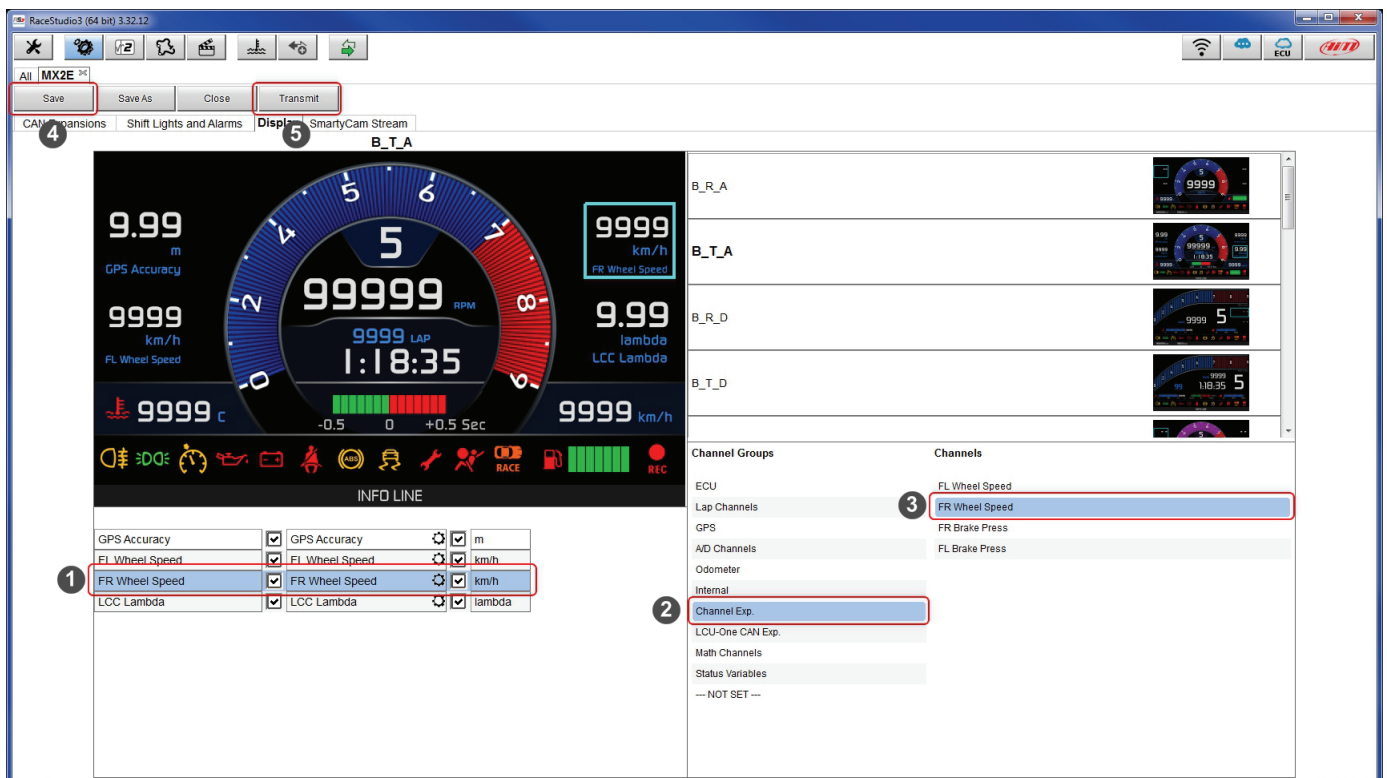

5.2.4 – SmartyCam configuration

MX2E can be connected to SmartyCam HD and SmartyCam GP HD.

Normally no configuration is needed but if additional sensors have been installed it is possible to see specific channels on SmartyCam video; to do so:

- activate the related layer
- it shows all channel/sensors that satisfy the selected function
- if the desired channel is not in the list enable “Enable all channels for functions” checkbox and all channels/sensors are shown.

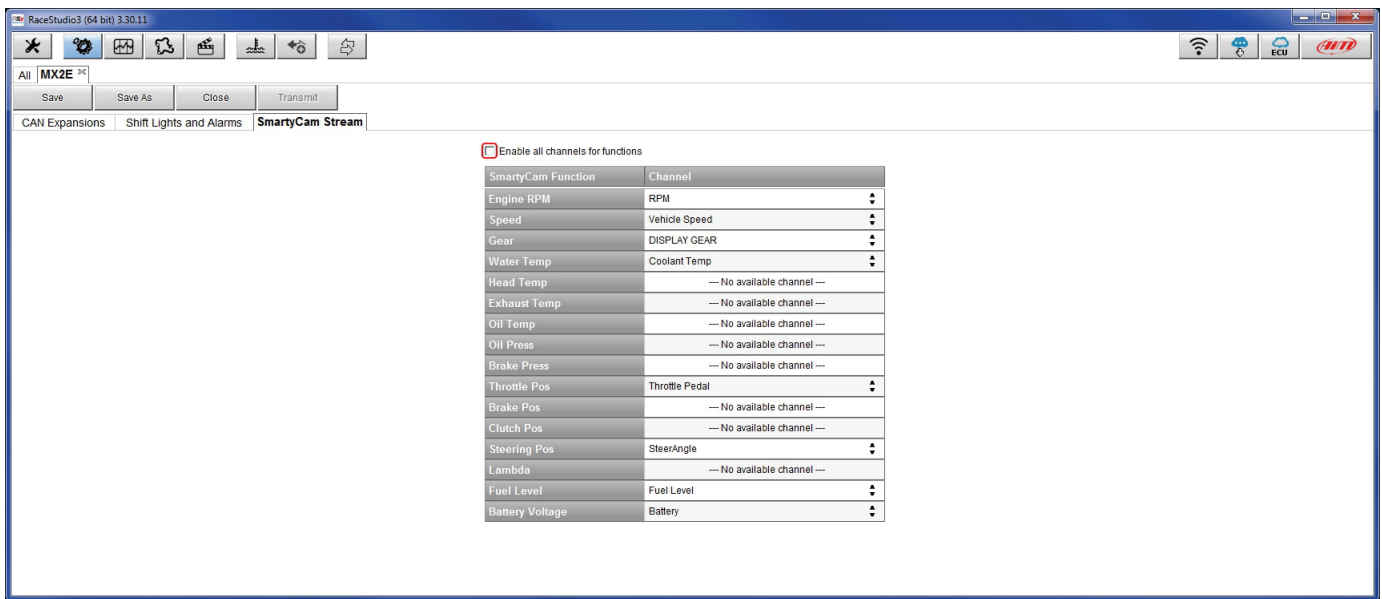

When the configuration is finished:

- press “Save” on the page top keyboard
- press “Transmit” to transmit the configuration to MX2E

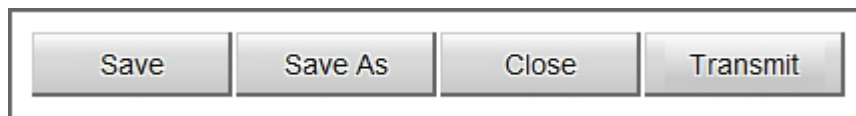

5.3 – Managing a track on MX2E with Race Studio 3

With Track Manager function of Race Studio 3 tracks can be created, deleted and modified, transmitted and received to/from MX2E. Press “Tracks” icon.



The main page is divided in three columns; on the **left**:

- on top, the filters that allow to collect many tracks following customized criteria; by default, all tracks are shown (light blue “All Tracks” filter in the image below).
- bottom left, the connected devices (in the image, “MX2E ID 7400104”)

The column **in the middle** shows:

- on top a fast search bar that allows to select the tracks which satisfy personal research criteria; pressing “?” a pop-up window explains research criteria (highlighted in red below), to say:
 - long name is the name in bold in each track box
 - short name is the track name shown on the display and is top right of each track box
 - track city is the name of the city the track is located in
- all the tracks listed in Race Studio 3 database. It automatically updates at start up if a connection to the Internet is available.

The column on the **Right** shows:

- the data sheet of the track you are mousing over.

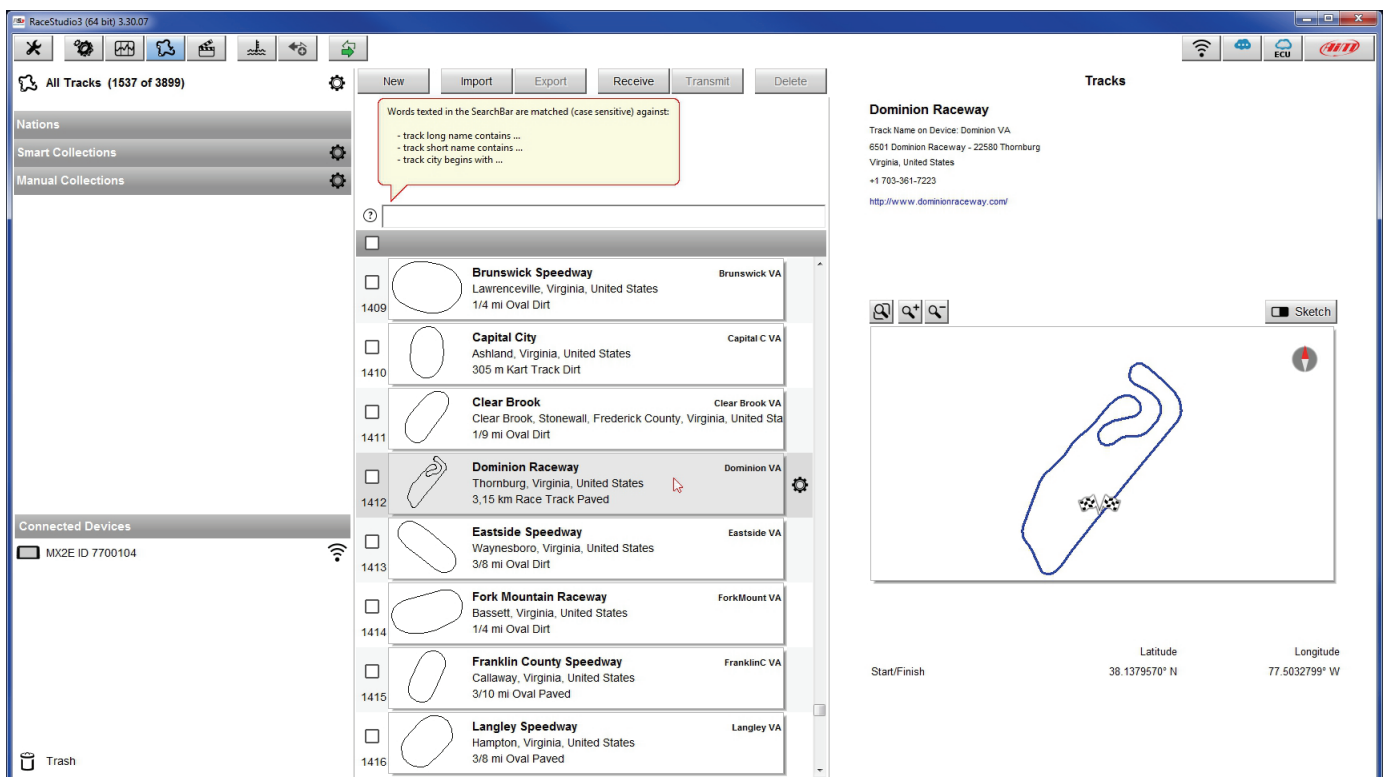



When MX2E is connected it is shown on the left bottom part of the page. Clicking on it all the tracks it contains are shown in the right column of the page.

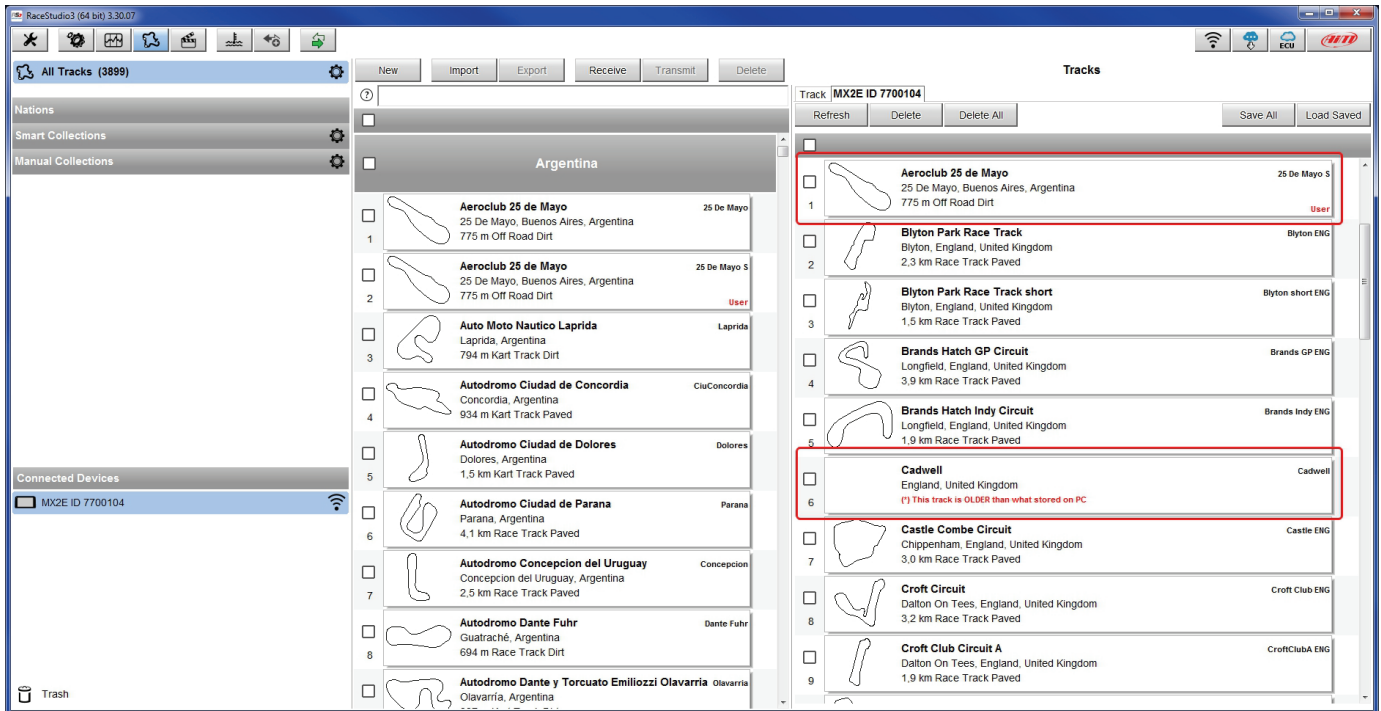

Tracks created by the user are labelled "User" and if the track stored in MX2E logger is different from the one stored in AiM database this is notified as shown here above.

The page keyboards are used to manage the tracks.

The keyboard above the central column allows to:



- **New:** create a new track
- **Import:** import one or more tracks stored in the device or in another external device
- **Export:** export one or more tracks to a specific PC folder or to another peripheral device
- **Receive:** receive from the connected device tracks user created (if no device is connected the button is disabled)
- **Transmit:** transmit one or more tracks from the PC to the connected device (if no device is connected the button is disabled)
- **Delete:** delete one or more tracks from Race Studio 3 database

The keyboard above the right column allows to:

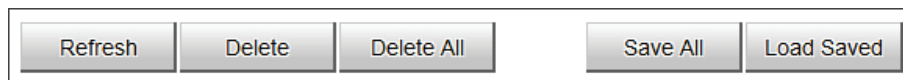

- **Refresh:** refresh the track list stored in the connected device
- **Delete:** delete one or more tracks from the device memory
- **Delete All:** delete all tracks stored in the device memory
- **Save all:** save all the tracks stored in the connected device; it creates a zip file that can be loaded to another AiM device
- **Load Saved:** load the tracks previously saved in the device memory

Since the software is constantly updated, may be other information or features will be available soon. Please check AiM website www.aim-sportline.com, documentation area, software section "Track Manager" manual.

5.4 – The device window

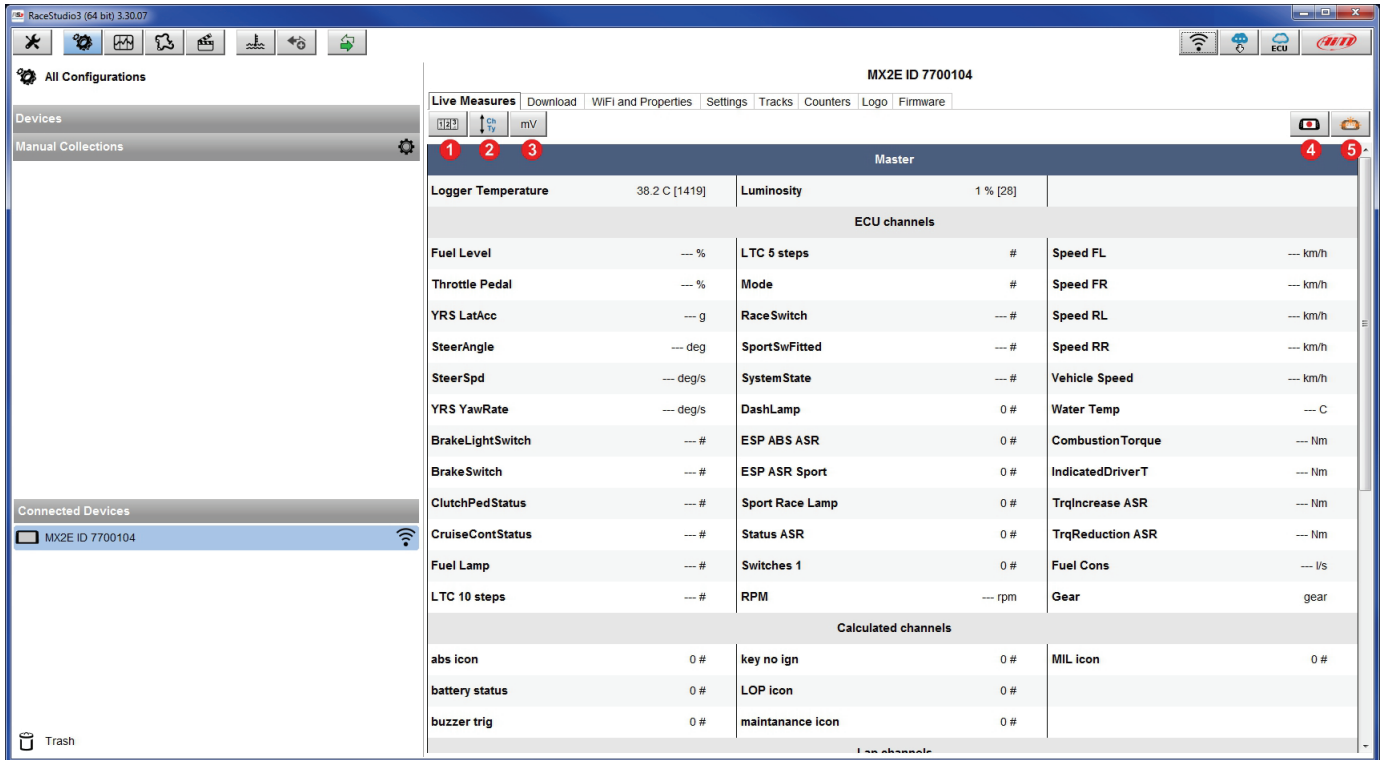

The device page is shown clicking on the device bottom left of the software page. Here are:

- **Live Measures:** to check the logger channels and force online values; using the buttons placed top of the layer is possible to:
 - start/stop live measures (1)
 - decide how to show the channels (2): as managed by the firmware (by configuration), in alphabetical order, by channel type (shown by device than by channel type and then by measure type)
 - show measure in Mv (3)
 - start/stop recording (4)
 - make MX2E blinking (5); this operation is the most simple way to test PC-device communication
- **Download:** download data stored in MX2E memory
- **WiFi and Properties:** name the device, manage MX2E WiFi and fill in racer name, vehicle name or number, championship and venue type (generic, qualifying, test, warm up, race, test type)
- **Tracks:** manage the tracks stored in the device memory
- **Counters:** to set/reset odometers
- **Logo:** transmit/receive the logo that shows up at switch on; supported image formats are JPEG or BMP; always use the most recent Windows™ version (Windows8 or Windows10) whose graphical libraries are more updated
- **Firmware:** to check or update MX2E firmware.

5.4.1 – Live measures page

When the configuration has been transmitted “Live Measures” page shows ECU channels too*; as said before it is now possible to perform some operations, like start recording and make MX2E blink pressing the top right buttons (4 and 5 in the previous image).

*Please refer to Appendix 1 to know which ECU channels are sampled by MX2E.

5.4.2 – Online value forcing

Live Measure layer of Device page offers a very useful function that allows to simulate one or more channels to test icons, alarms, power output and harness behaviours.

We can for example test water alarm.

To force this value:

- mouse over the value to force and click the setting icon
- a popup menu shows up: select “Force Channel Value” and fill in the panel that shows up
- click “OK” and the corresponding value becomes red on the logger display.

The screenshot shows the RaceStudio3 interface with the 'Live Measures' page for MX2E ID 7700104. The 'Water Temp' channel is highlighted in red, indicating it is being forced. A 'Choose value' dialog box is open, allowing the user to set a forced value for 'Water Temp'. The dialog shows '32 bit Float' set to 105 and 'Step' set to 0.1. The 'OK' button is highlighted. A red box highlights the 'Force Channel Value' option in the context menu for 'Water Temp'.

Master			
Logger Temperature	37.6 C	Luminosity	1 %
ECU channels			
Fuel Level	--- %	LTC 5 steps	#
Throttle Pedal	---		#
YRS LatAcc	---		#
SteerAngle	---		#
SteerSpd	---		#
YRS YawRate	---		0 #
BrakeLightSwitch	---		0 #
Brake Switch	---		0 #
ClutchPedStatus	---		0 #
CruiseContStatus	---		0 #
Fuel Lamp	---		0 #
LTC 10 steps	---		0 #
		Sport Race Lamp	0 #
		Status ASR	0 #
		Switches 1	0 #
		RPM	--- rpm
Calculated channels			
abs icon	0 #	key no ign	0 #
battery status	0 #	LOP icon	0 #
buzzer trig	0 #	maintanance icon	0 #
		Speed FL	--- km/h
		Speed FR	--- km/h
		Speed RL	--- km/h
		Speed RR	--- km/h
		Vehicle Speed	--- km/h
		Water Temp	---
		Combustion Torque	---
		IndicatedDriverT	---
		TrqIncrease ASR	---
		TrqReduction ASR	--- Nm
		Fuel Cons	--- l/s
		Gear	gear
		MIL icon	0 #



Once forced the values are shown on the right of the page red boxed. Lateral "+" and "-" buttons allows to change the values used. In the image below Fuel Alarm and Water Temperature Alarm have been forced and the corresponding icons are red on MX2E display.

The screenshot shows the RaceStudio3 interface for MX2E ID 7700104. The main display area is divided into several sections: Master, ECU channels, and Calculated channels. The Fuel Level and Water Temp values are highlighted in red boxes. On the right side, there are two control panels for Fuel Level and Water Temp, also highlighted in red boxes, with '+' and '-' buttons for adjustment.

Master			
Logger Temper...	37.6 C	Luminosity	0 %
ECU channels			
Fuel Level	1 %	LTC 5 steps	#
Throttle Pedal	---	Mode	#
YRS LatAcc	---	RaceSwitch	---
SteerAngle	---	SportSwFitted	---
SteerSpd	---	SystemState	---
YRS YawRate	---	DashLamp	0 #
BrakeLightSwitch	---	ESP ABS ASR	0 #
BrakeSwitch	---	ESP ASR Sport	0 #
ClutchPedStatus	---	Sport Race Lamp	0 #
CruiseContStatus	---	Status ASR	0 #
Fuel Lamp	---	Switches 1	0 #
LTC 10 steps	---	RPM	---
Calculated channels			
abs icon	0 #	key no ign	0 #
battery status	0 #	LOP icon	0 #
buzzer trig	0 #	maintanance icon	0 #
MIL icon	0 #		

Fuel Level	
1 %	+ -

Water Temp	
105 C	+ -



6 – Data recall

At the end of the test sampled data can be recalled pressing “MEM/OK”.

First is “Today” page.
Press “PAGE”

TODAY 09:05AM

MAX RPM		MAX SPEED	
10048		282	
Lap	Best Laps	RPM	mph
4	1:57:56	10048 5592	280 73
11	1:57:94	10100 5450	277 70
8	1:58:02	10300 5700	278 69

Second is “Summary” page that shows all the last tests with date and place. Select the day you want to see and press “PAGE”.

TODAY 09:05AM

- 13/06/2019 - Donington ENG
- 09/06/2019 - Ellough Park ENG
- 08/06/2019 - Ellough Park ENG
- 09/06/2019 - Ellough Park ENG

Third is “Day Summary” page that shows all tests in a box with time of the test, number of laps and best lap of the test. Select the test to see and press “ENTER”.

YESTERDAY: Donington GP

02.02PM 17 Laps B 1.57.56	12.02AM 10 Laps B 1.50.46	10.43AM 11 Laps B 1.54.14
09.52PM 7 Laps B 1.55.56	09.02AM 9 Laps B 1.53.46	7.39AM 10 Laps B 1.55.16

This page is a histogram test summary.

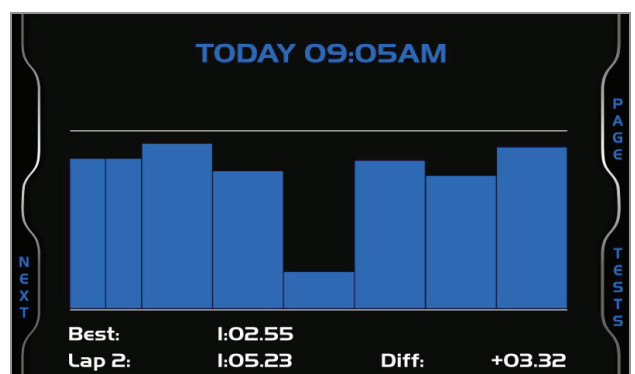

7 – Data download and analysis

Once the test session is over it is possible to download data sampled on a PC. Connect MX2E dash logger to a PC and click on it bottom left of the software page. Once reached the device page activate “Download” layer. It shows all the information concerning the file stored in the logger: number of laps, best lap, date/time, file dimensions. Select the file(s) to download and press “Download” button.

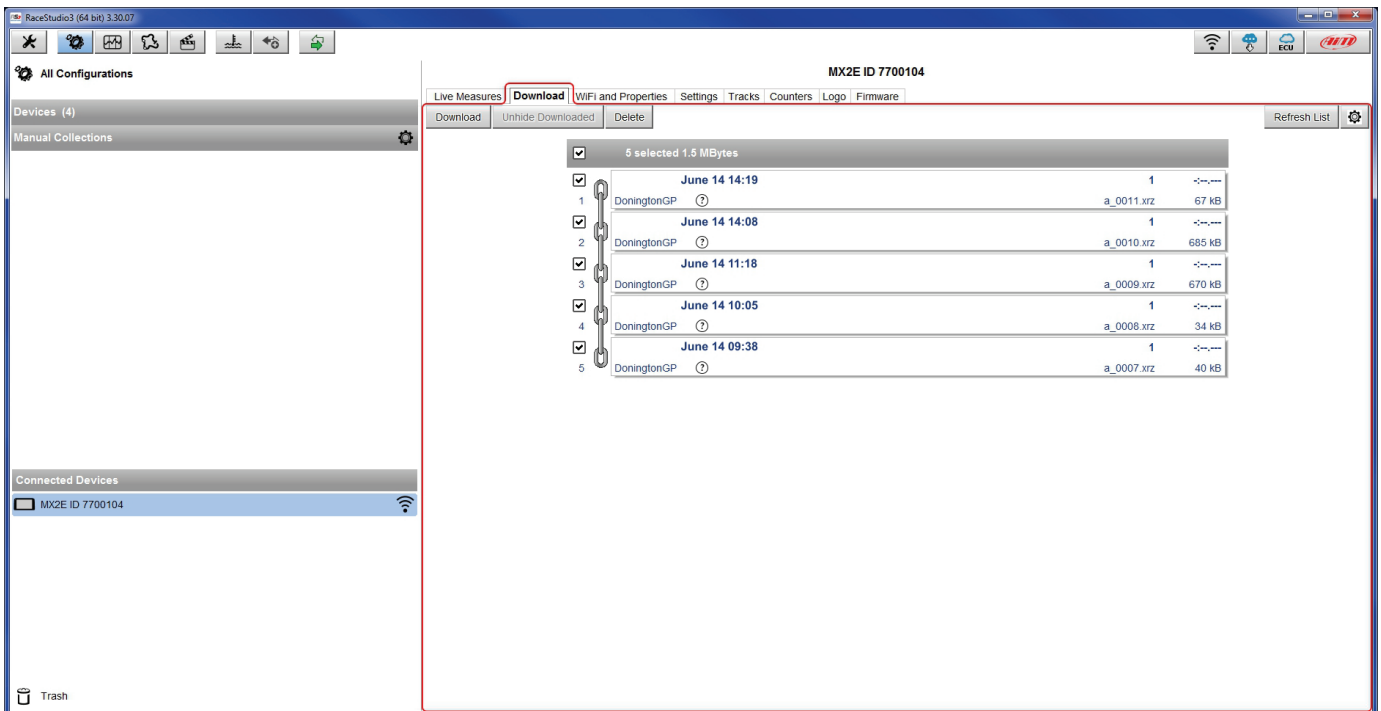

After download press Analysis Icon (📊) and Race Studio Analysis software starts showing all the files available for analysis. Double clicking on the desired one it is possible to start analysing your performance.

8 – Wi-Fi configuration

Two possible Wi-Fi connection modes are available.

1 – As an access point (AP – default)

This is the ideal configuration for one only device and one only computer. In this situation MX2E creates a Wi-Fi network and works as an Access Point the PC can be connected to.



2 – Existing network (to connect to an existing Wi-Fi network – WLAN)

This mode is complex and implies an external access point (AP) but it is also more flexible and powerful because allows the communication among more than one device and more than one computer in the same network. MX2E and the PC must connect to an existing Wi-Fi network made by a device that works as an external access point.

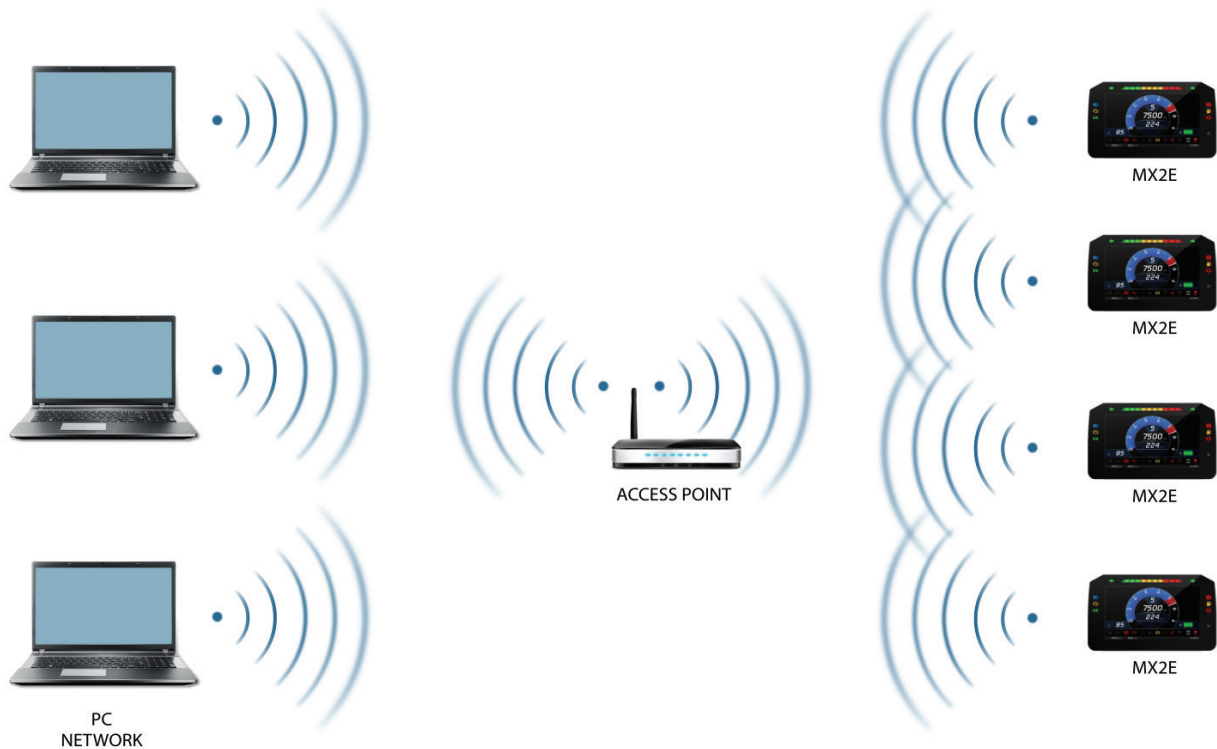

When working in WLAN mode MX2E has two available security levels:

- network authentication: network password
- device authentication: MX2E password

Both levels allow you the use of different strategies. A PC in WLAN, for example, can see several AiM devices but can communicate only with those he knows the password of.

Forgetting the password Wi-Fi configuration can be reset from MX2E menu as explained in paragraph 4.5.

8.1 – Configuring MX2E dash-logger as an access point (AP)

This is MX2E default configuration and is the easiest and most direct connection mode, ideal to communicate with one MX2E logger using one PC. It is free and so completely accessible by anyone. Please set an access password as soon as possible.

To establish a Wi-Fi connection:

- ensure that the Wi-Fi is enabled (set on Auto or on ON)
- read MX2E Name (700104 in the image below)



- run Race Studio 3
- click Wi-Fi icon and select your device
- in a few seconds the connection is established

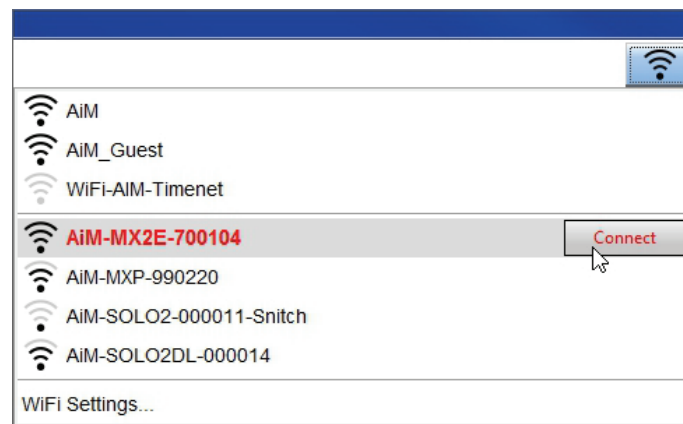



To set other parameters create a unique password to protect the device/ network. With a password the communication is safe and encrypted using WPA2-PSK standard.

Characters allowed in the password are all letters, also capital, all digits and these characters: '+_(){}\$£!?!^#@*\\"=~/%'
"Space" type can be used if it is not the first one because this could cause incomprehension in some Windows™ versions.

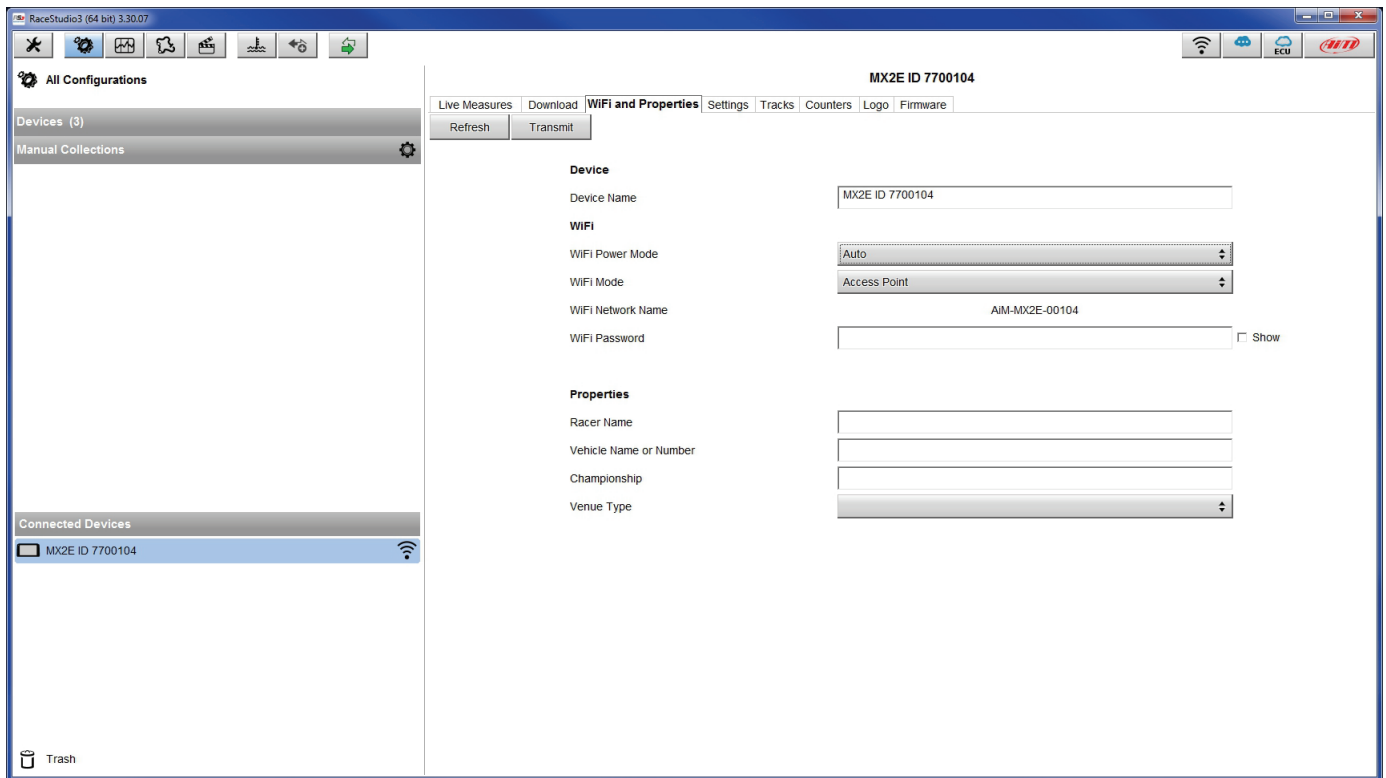

This AP or SSID name is unique for the device.
An example of name is: "AiM-MX2E-00104" where:

- "AiM" is the prefix of all AiM devices
- "MX2E" is the device identifier
- "00104" is device serial number assigned by the factory.

To make a device more recognizable a name can be added to the SSID. With the limit of eight characters. Allowed characters are all letters, capital too, all digits and these characters: '+ - _ () [] {}!.

"Space" type can be used provided that it is not the first one because it can cause incomprehension in some Windows™ versions.

Adding, for example, the driver's name, Tom Wolf, the network name (SSID) becomes:

"AiM-MX2E-00104-Tom Wolf"

Once all parameters set click "Transmit". MX2E logger reboots and is configured with the new parameters. If MX2E logger is protected by a password, as recommended, Race Studio 3 will ask that password to authenticate.

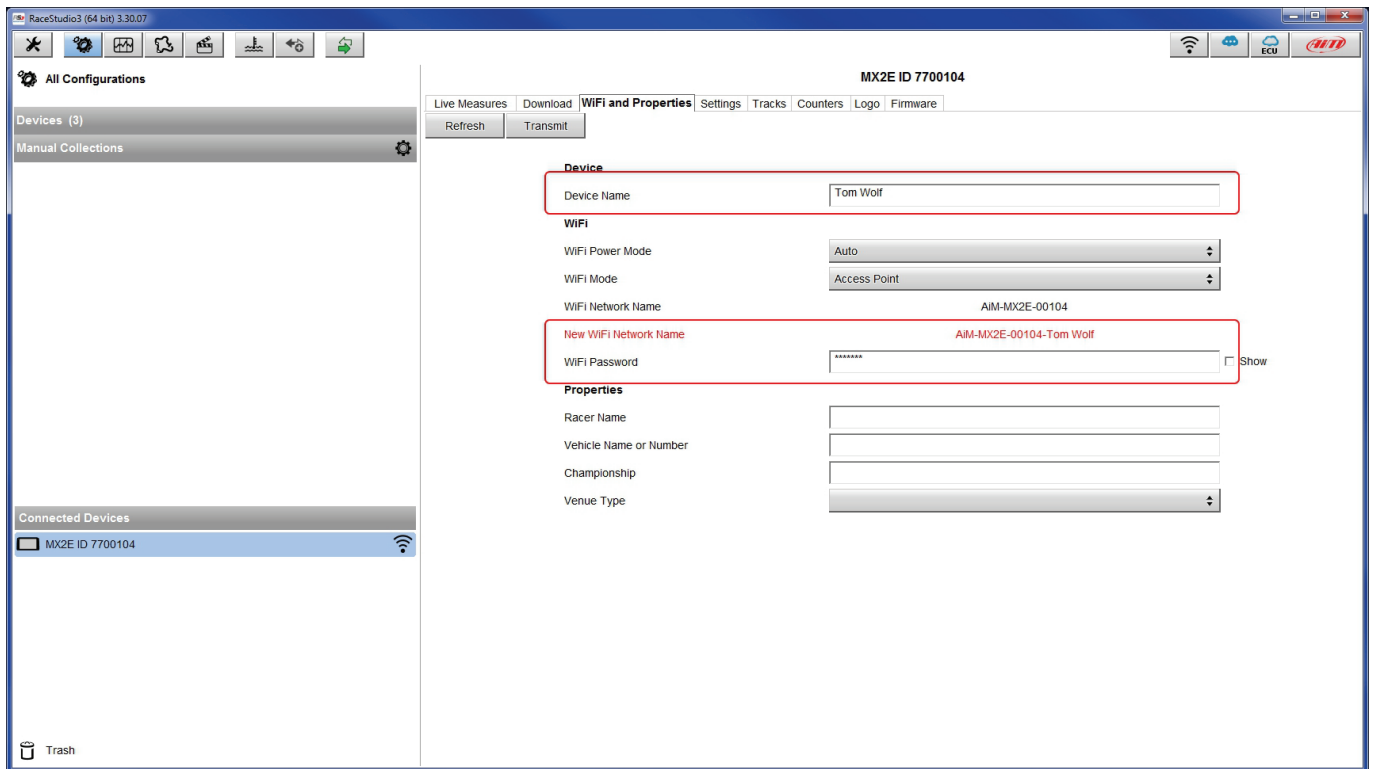

Please Note: the same Wi-Fi connection can be created with the operative system tool.
Once the device has been authenticated in the Wi-Fi network it can communicate using Race Studio 3.

8.2 – Adding MX2E loggers to an existing network

This situation is ideal for a team with multiple drivers and staff members and is desired to communicate with one or more AiM devices using the same PC network. Each MX2E logger can have its password that adds another security and privacy level to the network.

Enter “Wi-Fi and properties” tab and set it on “Existing Network”; fill in network name, network password and device password.

Transmit the network settings to the device clicking “Transmit”: it reboots and joins that network.

Please note: the only admitted password are those following WPA2-PSK standard.

To complete this procedure use Race Studio 3 software as here explained.

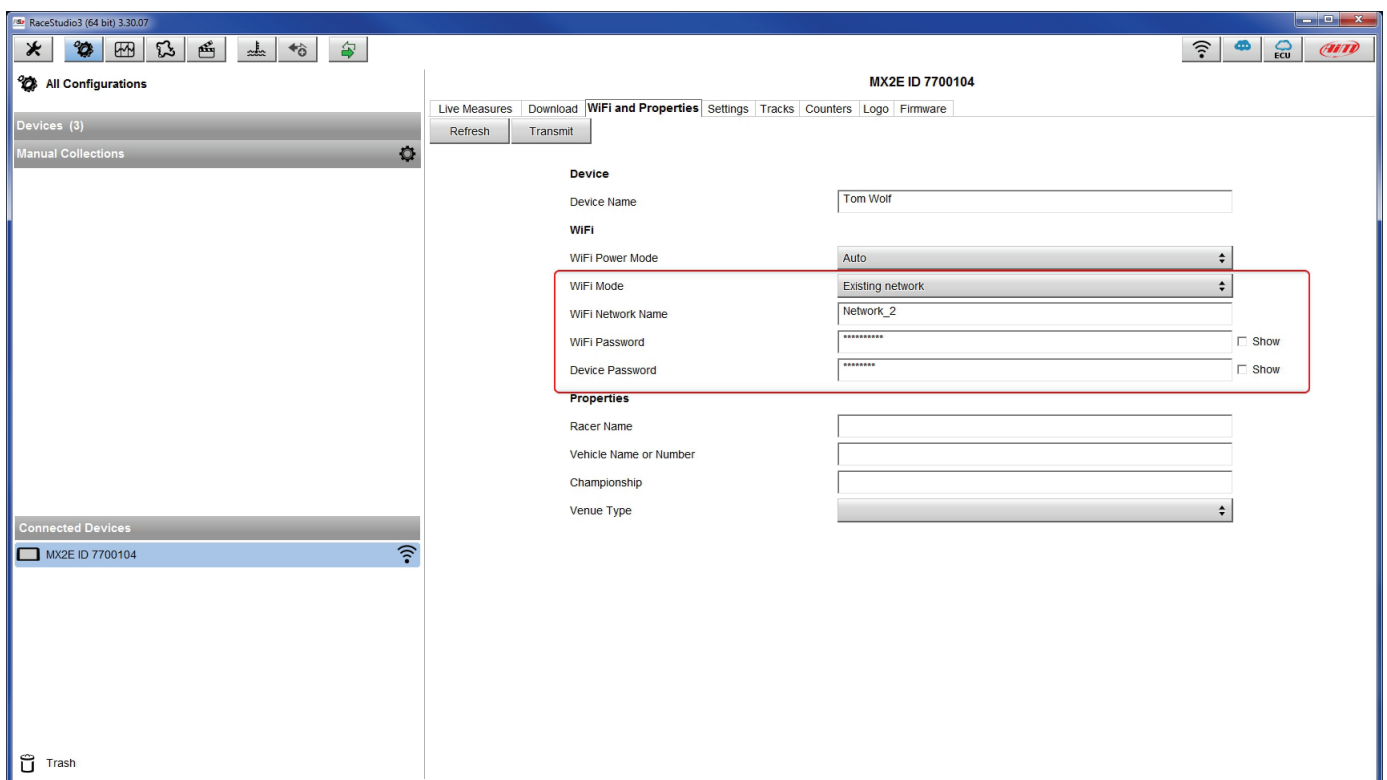

Here above is shown a device “MX2E ID 7700104” that switched from AP to WLAN mode (Existing Network).

Network name is “Network_2” and does not work with free access because is protected by a password.

To obtain connectivity on the device the PC has to be authenticated to the same network as shown here below.

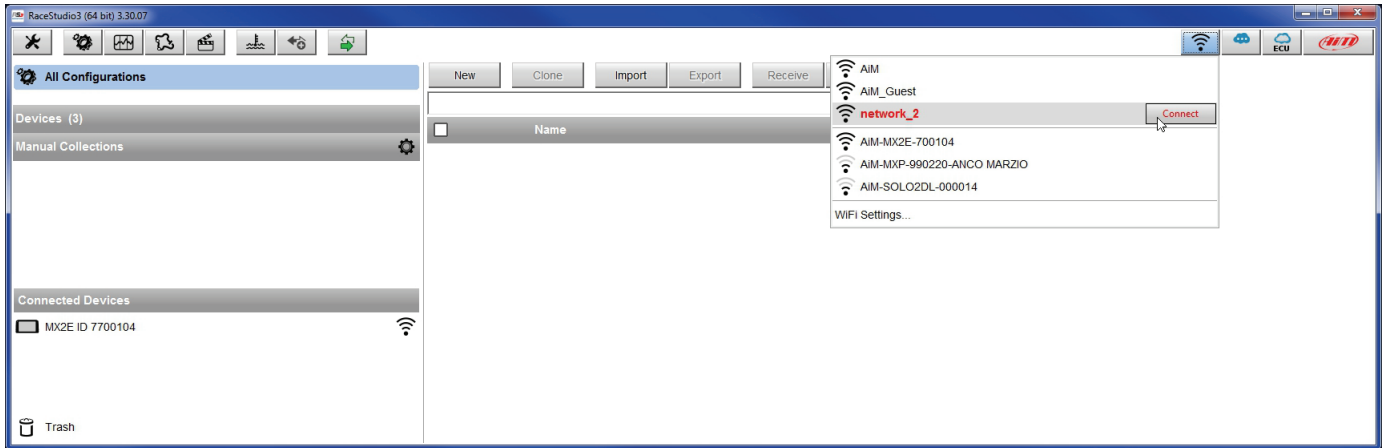

When the PC is authenticated to the network called "Network_2" it can see all devices you configured to access the same network. In the image below three AiM devices are connected to the same "Network_2" WLAN.

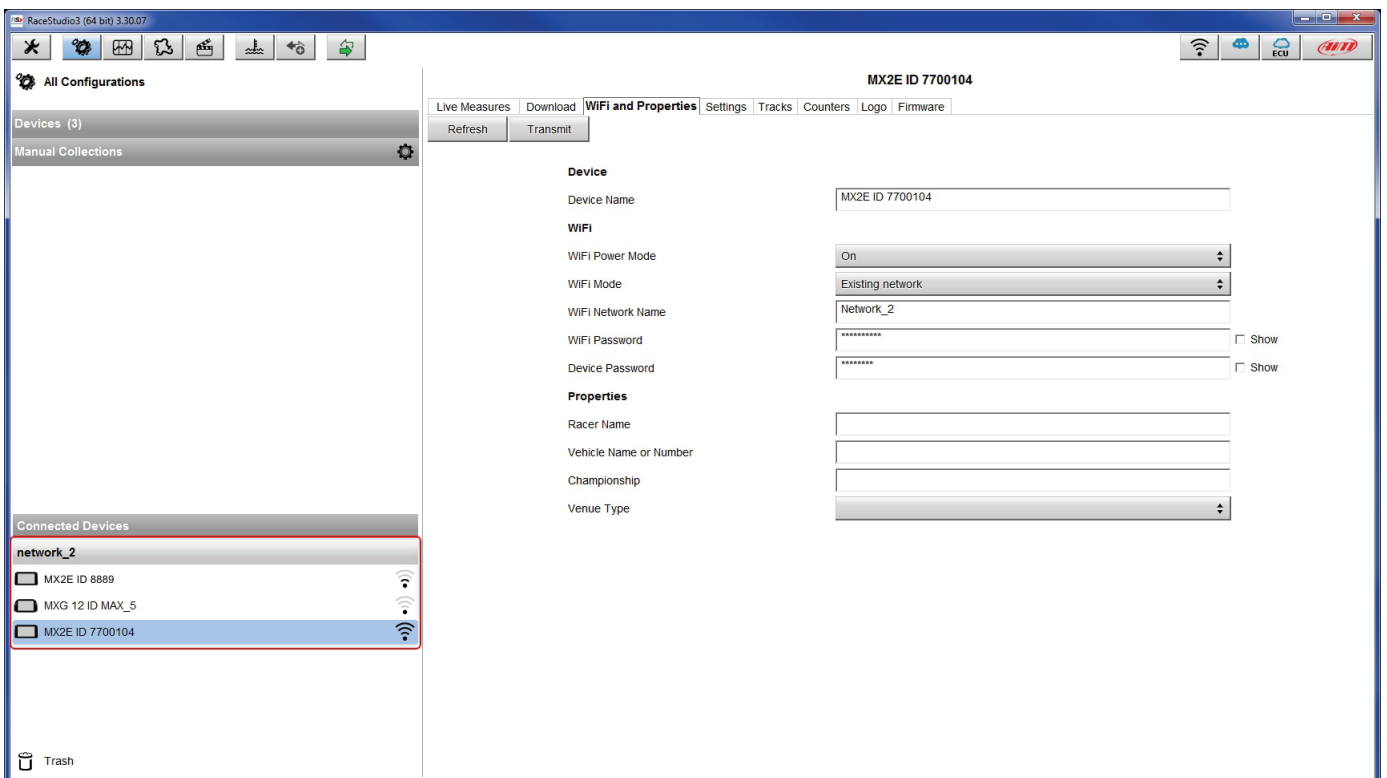

8.3 – Wi-Fi network settings

In this chapter is a short description of how to configure a WLAN including AiM devices and a PC.

Here below is an example of configuration.

ROUTER SETTINGS	
Use this section to configure the internal network settings of your router. The IP Address that is configured here is the IP Address that you use to access the Web-based management interface. If you change the IP Address here, you may need to adjust your PC's network settings to access the network again.	
Router IP Address :	<input type="text" value="192.168.0.1"/>
Subnet Mask :	<input type="text" value="255.255.255.248"/>
Device Name :	<input type="text" value="Network_2"/>
Local Domain Name :	<input type="text"/> (optional)
Enable DNS Relay :	<input checked="" type="checkbox"/>

DHCP SERVER SETTINGS	
Use this section to configure the built-in DHCP Server to assign IP addresses to the computers on your network.	
Enable DHCP Server :	<input checked="" type="checkbox"/>
DHCP IP Address Range :	<input type="text" value="192.168.0.2"/> to <input type="text" value="192.168.0.6"/>
DHCP Lease Time :	<input type="text" value="10080"/> (minutes)
Always Broadcast :	<input checked="" type="checkbox"/> (compatibility for some DHCP Clients)
NetBIOS announcement :	<input type="checkbox"/>
Learn NetBIOS from WAN :	<input type="checkbox"/>
NetBIOS Scope :	<input type="text"/> (optional)
NetBIOS node type :	<input checked="" type="radio"/> Broadcast only (use when no WINS servers configured) <input type="radio"/> Point-to-Point (no broadcast) <input type="radio"/> Mixed-mode (Broadcast then Point-to-Point) <input type="radio"/> Hybrid (Point-to-Point then Broadcast)
Primary WINS IP Address :	<input type="text"/>
Secondary WINS IP Address :	<input type="text"/>

For better network performances we suggest the use of a network device equipped with a DHCP server and using 3x3 MIMO technology like, for example a Linksys AS3200.

To maximize the bandwidth the Internet should not be allowed on this WLAN; this means the DHCP server should be configured without any DNS address nor gateway by default.



The parameters for the device network configuration in this example are:

- **Wireless network name: Network_2**
It means that the WLAN network name is "Network_2." A PC has to be authenticated in this network to interact with any AiM device of this network.
- **Gateway address: 192.168.0.1**
primary DNS server: 0.0.0.0
secondary DNS server: 0.0.0.0
(These settings prevent Internet connectivity on this WLAN.)
- **Subnet mask: 255.255.255.248**
Enable DHCP server: yes
DHCP IP address range: 192.168.0.2 to 192.168.0.6

These settings enable a DHCP server running on this WLAN and provide an IP address in a 2-6 range. This means that this network allows 5 network hosts.

The number of devices on a WLAN network depends on the subnet mask. Here below are typical examples of network masks and IP addresses range.

The configuration in bold is the one we suggest (if a greater number of devices is not needed), being the one that makes it easier and quicker for Race Studio 3 the identification of the devices in the network.

Subnet mask:	IP address range:	Number of devices:
255.255.255.0	192.168.0.1 – 254	254
255.255.255.128	192.168.0.1 – 126	126
255.255.255.192	192.168.0.1 – 62	62
255.255.255.224	192.168.0.1 – 30	30
255.255.255.240	192.168.0.1 – 14	14
255.255.255.248	192.168.0.1 – 6	6

8.4 – The Internet connectivity

For an optimal speed of AiM device(s) it is recommended not to allow the Internet on the same network and to set the WLAN in the same way.

The Internet access can of course be allowed on the network but this would degrade the communication.

This slightly slower speed can be suitable but a second Wi-Fi connection through an additional hardware (NIC) is to be preferred.

This configuration would provide an optimal speed of the data network of your AiM device(s) and at the same time would provide an internet connectivity with the second NIC.

8.5 – Connection issues

It can occur that MX2E logger is correctly connected to Race Studio 3 via Wi-Fi but the user interface does not show it. This may be because Wi-Fi port setting is set with a static IP. To switch it to dynamic (DHCP):

- open "Network and sharing centre" in the Windows™ research engine
- right click on the Wi-Fi connection and a panel shows up
- select "Properties" option
- double click on "Internet Protocol version 4 (TCP/IPv4)"
- verify that option "Obtain an IP address" is active

For further information refer to FAQ section, Wi-Fi of www.aim-sportline.com.

8.6 – Working on Mac™ with virtualized Windows™

Race Studio 3 only works on Windows™ operative systems; Mac users can use a virtualized Windows™ machine.

The main problem is that the host OS (Mac) must share its Wi-Fi interface with the virtualized operative system (Windows) as Ethernet interface and not as Wi-Fi interface.

Configuring Parallels(™)

Select “Menu → Configure...” in Parallels.

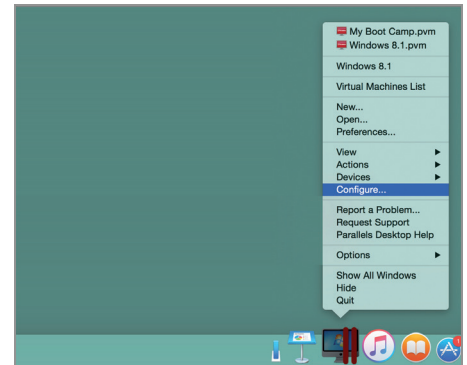

Press “Hardware” – top on the page that shows up – and select “Network” in the drop-down menu on the left.

Right on the configuration panel set "Type" field on “Wi-Fi”.

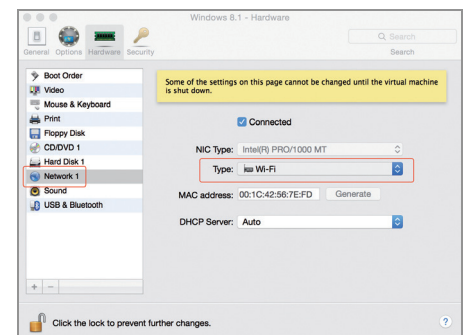

Then select the device to communicate with.



To ensure that the communication works select “Open Network preferences...” menu.

Verify that the status in the window that shows up is “Connected” and that the IP address associated is, for example, 10.0.0.10 (could be 10.0.0.11, 10.0.0.12, or generically 10.0.0.x).

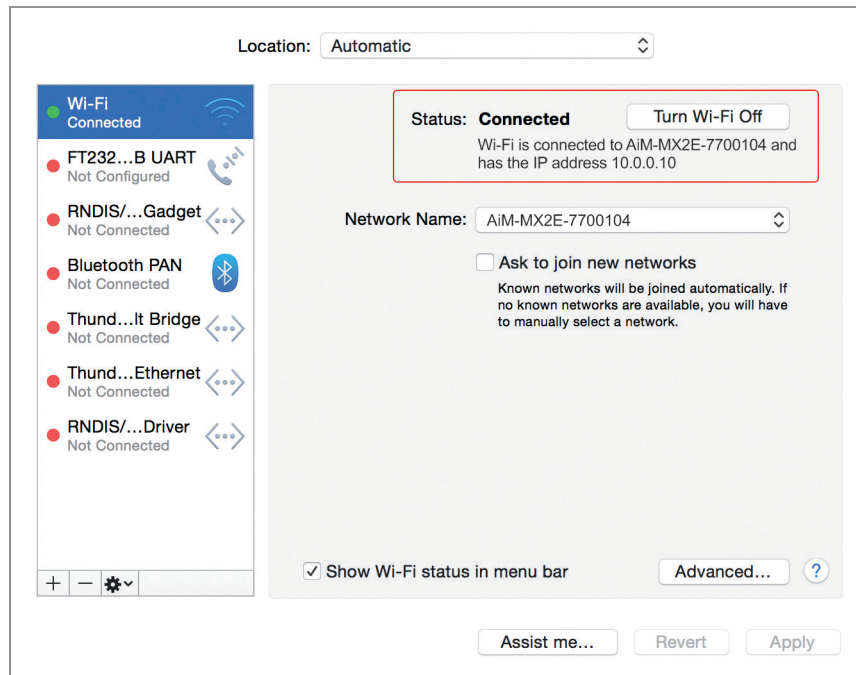

To enable Race Studio 3 correctly working on a Mac with virtualized Windows™.

- press Wi-Fi icon
- select “Wi-Fi Settings” option

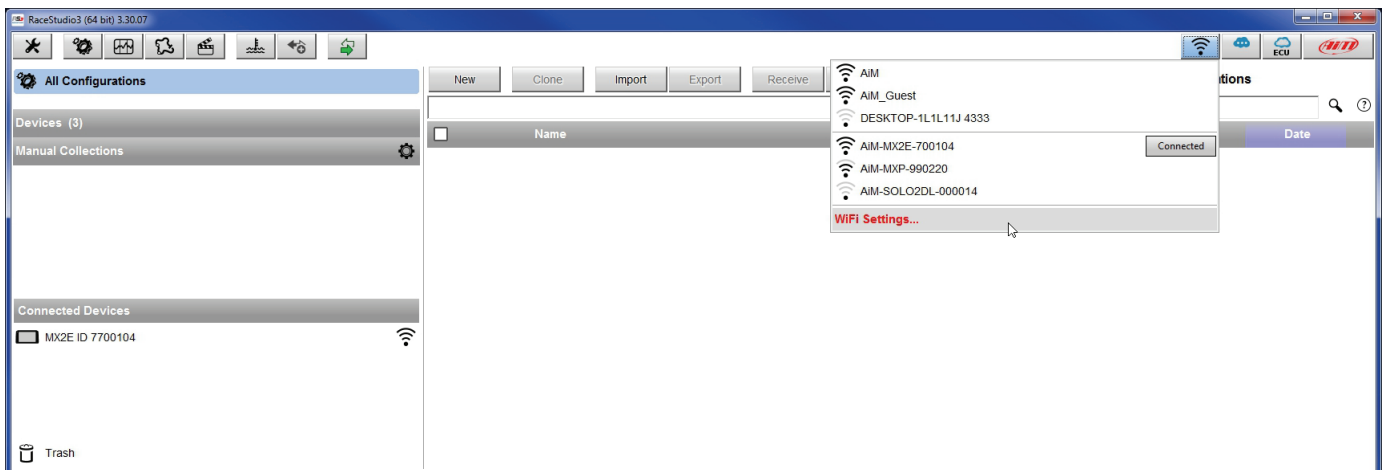

- enable the checkbox shown here below.



8.7 – Connected device visualization issues

It may occur that using Race Studio 3 on an iMac with virtualized Windows the device connected via Wi-Fi takes some time to be shown in the network or is not shown at all. This is why we always suggest using an Wi-Fi (WLAN) router.

This router works as an Access Point allowing more external devices to connect to its network. MX2E logger Wi-Fi configuration is to be set on Existing Network as explained before.

9 – New firmware upgrade



Our technicians and engineers are constantly working to improve both the firmware (the application that manages the device) and the software (the application installed on the PC).

Each time a new firmware and/or software version is available the icon here above appears with an arrow indicating that something is available for download (otherwise the icon only shows the cloud).

Click it and freely download the new applications.

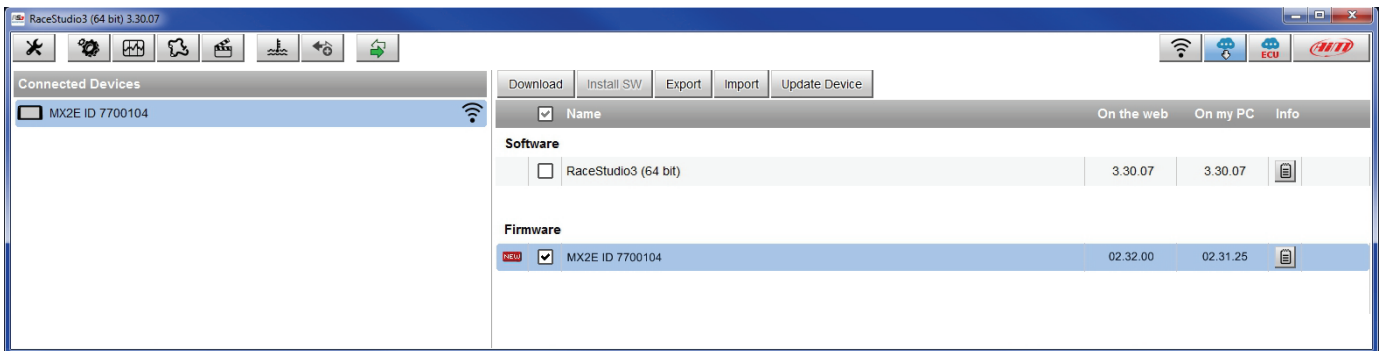

Once the new firmware has been downloaded connect the device to the PC via Wi-Fi to perform a firmware upgrade. In a few seconds the device is ready.

10 – Rear cameras connection and management

MX2E logger can manage rear cameras through the 5 pins Binder 712 female connector placed bottom right on the back of MX2E and labelled “Mirror Camera” as shown here below. The connector allows the connection of up to two analog cameras.



Once the rear camera(s) connected, MX2E automatically “sees” it/them and allows you to set it/them through the logger keyboard; press “MENU” button, scroll up to “REVERSE CAMERA” and set it as explained in paragraph 4.3.

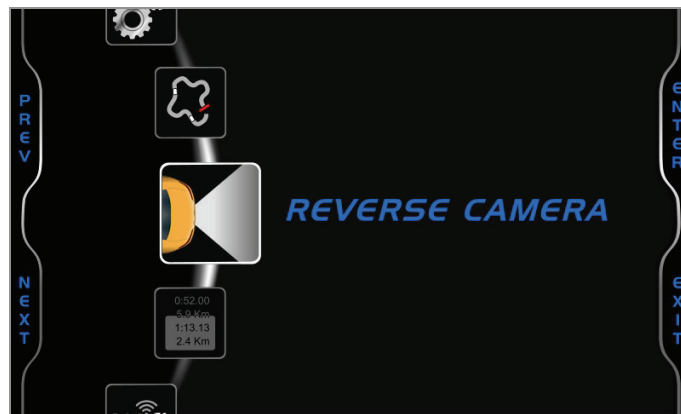

If no key is pressed in 5 seconds, the menu disappears and the logger shows the camera image in live streaming, that is very useful to check the camera position. Images below shows the image of the camera to set on the left and the live stream on the right.

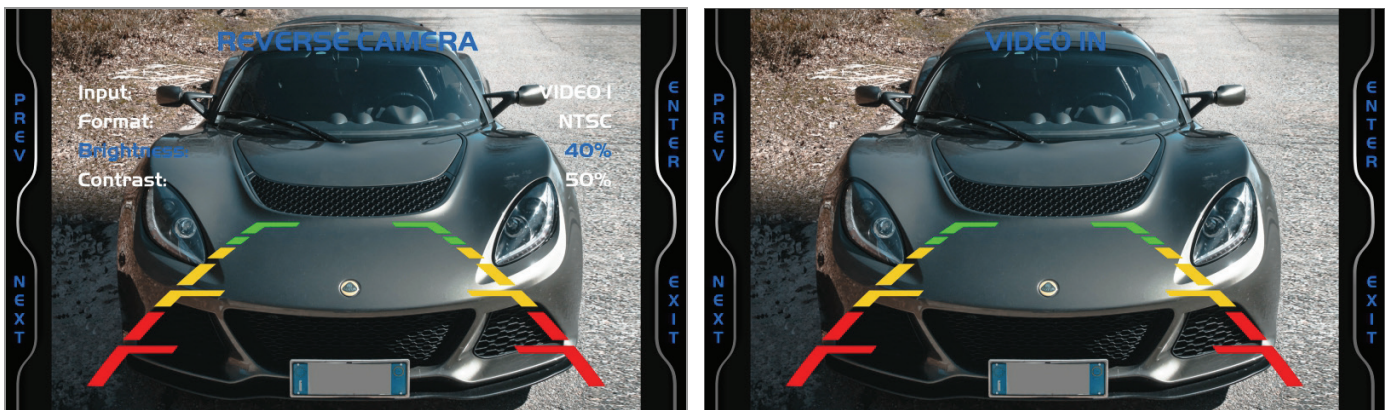



Appendix 1 – ECU channels logged by MX2E

MX2E sample and records the channels supplied by the ECU according to the vehicle model year.

Lotus Elise-Exige 2004-2007.

CHANNEL NAME	CHANNEL FUNCTION	SAMPLING FREQUENCY
RPM	Engine RPM	50
Vehicle Speed	Vehicle Speed	10
Water_Temp	Engine Cooling Temperature	10
Fuel Level	Fuel level percentage	10
Bitfield1	1=MILlight 2=Low Oil Pressure 3=Traction Control light	10

Lotus Elise-Exige 2008-2010.

CHANNEL NAME	CHANNEL FUNCTION	SAMPLING FREQUENCY
RPM	Engine RPM	50
Vehicle Speed	Vehicle Speed	50
Water_Temp	Engine Cooling Temperature	10
IntakeAirTemp	Intake Air Temperature	10
Fuel Level	Fuel level percentage	10
PPS	Throttle Pedal Percentage	20
TPS	Throttle Position	20
CuSelLTC	Selected Traction Control Information	20
MAF	Mass Air Flow Rate	20
Bitfield1	3=MILlight 4=Low Oil Pressure 5=Traction Control light	10
Bitfield2	0=ServiceLight 4=ECTlight	10

**Lotus Elise-Exige 2011-2019.**

CHANNEL NAME	CHANNEL FUNCTION	SAMPLING FREQUENCY
RPM	Engine RPM	100
GEAR	Gear	10
Vehicle Speed	Vehicle Speed	100
Speed FL	Front Left Wheel Speed	100
Speed FR	Front Right Wheel Speed	100
Speed RL	Rear Left Wheel Speed	100
Speed RR	Rear Right Wheel Speed	100
YRS_LatAcc	Lateral Acceleration	100
YRS_YawRate	Yaw Rate	100
SteerSpd	Steering Speed	20
Water_Temp	Engine Cooling Temperature	10
SteerAngle	Steering angle	20
Fuel Level	Fuel level percentage	1
Throttle_Pedal	Throttle Pedal Percentage	100
Fuel_Cons	Fuel Consumption	10
TrqReduction_ASR	Torque Reduction	20
TrqIncrease_ASR	Torque Increase	20
IndicatedDriverT	Torque	10
Combustion Torque	Combustion Torque	10
System State	System State	10
Mode	0 = Normal 1 = Sport 4 = Race	10
CruiseContStatus	Cruise Control Status	10
SportSwFitted	Sport Switch Present	10
Race Switch	Race Switch	10
Brake Switch	Brake Switch	10
BrakeLightSwitch	Brake Light Switch	10
Fuel Lamp	Fuel Lamp Activated	10



ClutchPedStatus	Clutch Pedal Status	10
LTC_5_steps	Lotus Traction Control - 5 steps	10
LTC_10_steps	Lotus Traction Control - 10 steps	50
Sport_Race_Lamp	Sport Race Lamp State	50
Switches_1	Switches State	10
ESP_ASR_Sport	ESP ASR switch state	10
ESP_ABS_ASR	1 = ABS error 2 = ABS intervention 3 = ASR error 4 = ASR intervention 5 = ASR info lamp 6 = ESP error status 7 = ESP intervention 8 = ESP info lamp	10
Dash Lamps	1 = Coolant temperature flash 2 = TPMS Lamp 3 = Service lamp 4 = Low oil pressure lamp 5 = Malfunctioning indicator lamp 6 = Shift lamp 1 7 = Shift lamp 2 8 = Shift lamp 3	10
Status_ASR	ASR Status	10

Appendix 2 – MX2E Adapter harness

Here below is MX2E adapter harness, needed for Lotus Elise-Exige 2004-2007 version with airbag only.

Please remember models without airbag are not supported.

